



# DRIVE DEVILBISS® 10-LITER OXYGEN CONCENTRATOR SERVICE MANUAL



**DANGER – NO SMOKING**



MODEL 1025DS  
MODEL 1025KS  
MODEL 1025UK



**CAUTION**

Federal (U.S.A.) law restricts this device to sale by or on the order of a physician.

Assembled in USA

# TABLE OF CONTENTS

## GENERAL INFORMATION

Introduction.....	3
Symbol Definitions.....	3
Important Safeguards.....	3

## UNPACKING AND SETUP

Initial Inspection.....	6
Patient Setup.....	6
Operating Instructions.....	6

## MAINTENANCE

Patient Alert System.....	8
Alarm Function Testing.....	8
Service Life.....	9
Routine Patient Maintenance.....	9
Periodic Homecare Provider Preventative Maintenance.....	9
Preventative Maintenance Summary.....	10
Provider's Notes.....	10

## TROUBLESHOOTING

System Operation.....	12
Normal Operating Sequence.....	12
Simplified Troubleshooting.....	13
Troubleshooting Chart A.....	14
Troubleshooting Chart B.....	15
Troubleshooting Chart C.....	15
Troubleshooting Chart D.....	15
Troubleshooting Chart E.....	16
Troubleshooting Chart F.....	16

## COMPONENT TESTING, REPAIR, AND REPLACEMENT

Proper Repair Procedures.....	17
Cabinet Removal.....	17
Accumulator Tank.....	17
Accumulator Pressure Test.....	17
Auxiliary Oxygen Port.....	18
Capacitor.....	18
Check Valves.....	19
Compressor.....	19
Cooling Fan.....	22
Flow Meter.....	22
Hour Meter.....	22
Manifold.....	22
Molecular Sieve Beds.....	23
Power Cord.....	23
Power Switch.....	23
Pressure Regulator.....	24
Printed Circuit Board (PC Board).....	24
Rotary Valve.....	25

## FIGURES, DIAGRAMS AND PARTS LIST

1025 Unit with Auxiliary Oxygen Port.....	26
Accessories and Tools.....	28
Pneumatic and Wiring Diagrams.....	29

## ORDERING INFORMATION AND PARTS RETURN

Ordering Information.....	31
Returns.....	31

## WARRANTY

Return and Disposal.....	32
--------------------------	----

<b>SPECIFICATIONS</b> .....	33
-----------------------------	----

<b>ELECTROMAGNETIC COMPATIBILITY INFORMATION</b> .....	34
--------------------------------------------------------	----

## INTRODUCTION

This service manual was designed to provide DeVilbiss Healthcare qualified service technicians and homecare providers with the proper maintenance, service, safety, and repair procedures for the Drive DeVilbiss Oxygen Concentrator.

Read and understand all the information contained in this service manual before attempting to operate or perform any maintenance on the concentrator.





























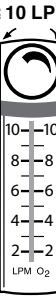

An oxygen concentrator is a device that delivers highly concentrated oxygen for therapeutic applications.

Room air is a mixture of 78% nitrogen, 21% oxygen, 1% argon and other gases. The concentrator draws in room air, separates the nitrogen from the oxygen, and delivers concentrated oxygen to the patient through an oxygen port.

For more in-depth classroom type training, contact the Respiratory Technical Service Department at 1-800-338-1988 (814-443-4881).





**NOTE**– DeVilbiss reserves the right to alter or change the design of the Drive DeVilbiss Oxygen Concentrator series. Hence, slight differences in construction or components may exist between the unit in hand and what is described in this manual.

## SYMBOL DEFINITIONS

	It is mandatory to read and understand the operating instructions prior to use. <b>i</b> This symbol has a blue background on the product label.		Off On		Catalog Number		LOT Number
	Electric Shock Hazard. Cabinet to be removed by authorized personnel only. <b>i</b> This symbol has a yellow background on the product label.		Reset		Serial Number		Manufacturer
	Danger - No smoking near patient or device. <b>i</b> This symbol has a red circle and diagonal bar on the product label.		Alternating Current		Normal Oxygen		European Representative
	Use no Oil, Grease or Lubricants <b>i</b> This symbol has a red circle and diagonal bar on the product label.		Type B applied part		Low Oxygen		European Rep CE mark
	Do not use near heat or open flames <b>i</b> This symbol has a red circle and diagonal bar on the product label.		Double Insulated		Service Required		Maximum recommended flow rate: 10 LPM
	General Warning <b>i</b> This symbol is used throughout this manual to indicate hazardous situations to avoid.		Hour Meter		TUV Rheinland C-US approval mark		
	Important Information <b>i</b> This symbol is used throughout this manual to indicate important information you should know.		Operating Temperature Range +5 to +35°C (+41 to +95°F)		TUV Rheinland Certified approval mark		
	Note and Information Symbol <b>i</b> This symbol is used throughout this manual to indicate notes, useful tips, recommendations and information.		Atmospheric Pressure Range 840 to 1010 hPa (Approximate sea level to 5000 ft)		Inmetro approval mark		
	Federal (U.S.A.) law restricts this device to sale by or on the order of a physician.						
	Ingress Protection - Protected against finger access to hazardous parts; protected against vertically falling water drops.						
	This device contains electrical and/or electronic equipment that must be recycled per EU Directive 2012/19/EU- Waste Electrical and Electronic Equipment (WEEE)						

## IMPORTANT SAFEGUARDS

Read this entire guide before using your DeVilbiss concentrator. Important safeguards are indicated throughout this guide. Pay special attention to all safety information. Imminently and potentially hazardous information is highlighted by these terms:

	<b>DANGER</b> Indicates an imminently hazardous situation which could result in death or serious injury to the user or operator if not avoided.
	<b>WARNING</b> Indicates a potentially hazardous situation which could result in death or serious injury to the user or operator if not avoided.
	<b>CAUTION</b> Indicates a potentially hazardous situation which could result in property damage, injury, or device damage if not avoided.
	<b>IMPORTANT</b> Indicates important information you should know.
	<b>NOTE</b> Indicates notes, useful tips, recommendations, and information.

## READ ALL INSTRUCTIONS BEFORE USING.



### DANGER

- Oxygen causes rapid burning. Do not smoke while your oxygen concentrator is operating, or when you are near a person utilizing oxygen therapy.
- Smoking during oxygen therapy is dangerous and is likely to result in facial burns or death. Do not allow smoking within the same room where the oxygen concentrator or any oxygen carrying accessories are located.
  - If you intend to smoke, you must always turn the oxygen concentrator off, remove the cannula and leave the room where either the cannula or mask or the oxygen concentrator is located. If unable to leave the room, you must wait 10 minutes after you have turned off the oxygen concentrator before smoking.
- Oxygen makes it easier for a fire to start and spread. Do not leave the nasal cannula or mask on bed coverings or chair cushions if the oxygen concentrator is turned on but not in use. The oxygen will make the materials flammable. Turn the oxygen concentrator off when not in use to prevent oxygen enrichment.
- Keep the oxygen concentrator and cannula at least 2 m (6.5 feet) from hot, sparking objects or naked sources of flame.
- Open flames during oxygen therapy are dangerous and are likely to result in fire or death. Do not allow open flames within 2 m (6.5 feet) of the oxygen concentrator or any oxygen carrying accessories.
- Drive DeVilbiss oxygen concentrators are equipped with a fire mitigating outlet fitting that prevents propagation of fire into the unit.



### WARNING

- To avoid electric shock, do not plug the concentrator into an AC outlet if the concentrator cabinet is broken. Do not remove the concentrator cabinet. The cabinet should only be removed by a qualified Drive DeVilbiss technician. Do not apply liquid directly to the cabinet or utilize any petroleum-based solvents or cleaning agents.
- Improper use of the power cord and plugs can cause a burn, fire or other electric shock hazards. Do not use the unit if the power cord is damaged.
- Ensure the mains power cord is fully inserted into the concentrator connector (230 volt units) and the power cord plug is completely inserted into a fully functioning AC wall outlet. Failure to do so may cause an electrical safety hazard.
- In order to prevent a fire propagating from the patient through the cannula towards the unit, a means of protection should be located as close to the patient as practicable. Country Standards may vary. Please contact your provider for information.
- Locate oxygen tubing and power supply cords to prevent tripping hazards and reduce the possibility of entanglement or strangulation.
- Do not lubricate fittings, connections, tubing or other accessories of the oxygen concentrator to avoid the risk of fire and burns.
- Do NOT use lubricants, oils or grease.
- Before attempting any cleaning procedures, turn the unit "Off."
- Use only water-based lotions or salves that are oxygen-compatible before and during oxygen therapy. Never use petroleum or oil-based lotions or salves to avoid the risk of fire and burns.
- Use only spare parts recommended by the manufacturer to ensure proper function and to avoid the risk of fire and burns.
- When using the Transfiller Caddy with a Transfill device, always keep the system on a flat surface. Disassemble the system prior to moving.
- If you feel discomfort or are experiencing a medical emergency while undergoing oxygen therapy, seek medical assistance immediately to avoid harm.
- Geriatric, pediatric or any other patient unable to communicate discomfort can require additional monitoring and/or a distributed alarm system to convey the information about the discomfort and/or the medical urgency to the responsible caregiver to avoid harm.
- Use of this device at an altitude above 5000 feet (1524 meters) or above a temperature of 95°F (35°C) or greater than 93% relative humidity may affect the flow rate and the percentage of oxygen and consequently the quality of the therapy. Refer to specifications for details regarding parameters tested.
- To ensure you receive the therapeutic amount of oxygen delivery according to your medical condition, the Oxygen Concentrator must:
  - be used only after one or more settings have been individually determined or prescribed for you at your specific activity levels.
  - be used with the specific combination of parts and accessories that are in line with the specification of the concentrator manufacturer and that were used while your settings were determined.
- Your delivery settings of the oxygen concentrator should be periodically reassessed for the effectiveness of therapy.
- For your safety, the oxygen concentrator must be used according to the prescription determined by your physician.
- Under certain circumstances, oxygen therapy can be hazardous. Seek medical advice before using an oxygen concentrator.

# GENERAL INFORMATION



## WARNING



### MR Unsafe

- Do not bring the device or accessories into a Magnetic Resonance (MR) environment as it may cause unacceptable risk to the patient or damage to the oxygen concentrator or MR medical devices. The device and accessories have not been evaluated for safety in an MR environment.
- Do not use the device or accessories in an environment with electromagnetic equipment such as CT scanners, Diathermy, RFID and electromagnetic security systems (metal detectors) as it may cause unacceptable risk to the patient or damage to the oxygen concentrator. Some electromagnetic sources may not be apparent, if you notice any unexplained changes in the performance of this device, if it is making unusual or harsh sounds, disconnect the power cord and discontinue use. Contact your home care provider.
- This device is suitable for use in home and healthcare environments except for near active HF SURGICAL EQUIPMENT and the RF shielded room of an ME SYSTEM for magnetic resonance imaging, where the intensity of Electromagnetic DISTURBANCES is high.
- Use of this equipment adjacent to or stacked with other equipment should be avoided because it could result in improper operation. If such use is necessary, this equipment and the other equipment should be observed to verify that they are operating normally.
- Portable RF communications equipment (including peripherals such as antenna cables and external antennas) should be used no closer than 30 cm (12 inches) to any part of the oxygen concentrator, including cables specified by the manufacturer. Otherwise, degradation of the performance of this equipment could result.



## CAUTION

- It is very important to follow your oxygen prescription. Do not increase or decrease the flow of oxygen – consult your physician.
- To prevent product damage, do not attempt to operate the unit without the air filter, or while the filter is still damp.
- The surface temperature of the exhaust vents on the bottom of the unit may exceed 105.8°F (41°C) under certain conditions.
- When device is used under extreme operating conditions, the temperature near the exhaust vents on the bottom of the unit may reach 138.2°F (59°C). Keep body parts a minimum of 30" (76.2 cm) away from this area.
- Use of harsh chemicals (including alcohol) is not recommended. If bactericidal cleaning is required, a non-alcohol based product should be used to avoid inadvertent damage.



## IMPORTANT

- It is recommended that the homecare provider lock the flow control knob to prevent inadvertent adjustment. A flow setting other than prescribed may affect the patient therapy.
- Do not service or clean this device while in use with a Patient.
- Do not use a low-output flow meter with this concentrator.
- The Device is classified as IP21 which means it is protected against finger access to hazardous parts and protected against vertically falling water drops.
- Equipment not suitable for use in the presence of a flammable anesthetic mixture with air or with oxygen or nitrous oxide.
- This device contains electrical and/or electronic equipment. Follow local governing ordinances and recycling plans regarding disposal of device components.

**SAVE THESE INSTRUCTIONS.**

# UNPACKING AND SETUP

## INITIAL INSPECTION

It is suggested that an initial inspection be performed upon receiving the oxygen concentrator.

1. After removing the Drive DeVilbiss Oxygen Concentrator from the carton, examine it for any external damage. If shipping damage has occurred, contact the DeVilbiss Customer Service Department at 1-800-338-1988 (814-443-4881) for specific instructions. Save the carton for possible later return; note the position of the unit and placement of the packing material.
2. Open the filter door and make sure the intake bacteria filter is in place.
3. Check to make sure the air cabinet filter is in place.
4. Plug the unit into an electrical outlet, turn the unit "On" and check the audible and visible alerts.
5. Record hours on the digital hour meter located on the light panel.
6. Set the flow meter to maximum recommended liter flow and let the unit run for at least 20 minutes.
7. Use an oxygen analyzer to check the concentration.
8. With unit still running, unplug it to test the power fail alarm.

**NOTE**– If the unit fails to operate properly (oxygen concentration not within specification) or if internal damage is found, contact the Drive DeVilbiss Customer Service Department at 1-800-338-1988 (814-443-4881).

## PATIENT SETUP

1. Position the unit near an electrical outlet in the room where the patient spends most of his or her time.



### WARNING

Do not connect to an electrical outlet controlled by a wall switch.

2. Position the unit at least 6 inches (16 cm) from walls, draperies, or any other objects that might prevent the proper flow of air in and out of the oxygen concentrator. The concentrator should be located in a well-ventilated area to avoid pollutants or fumes.
3. Locate the unit a minimum of 6.5 feet (2 m) from fireplaces, radiators, heaters, and hot-air registers.



### WARNING

Oxygen causes rapid burning. Do not smoke while your oxygen concentrator is operating, or when you are near a person utilizing oxygen therapy. Keep the oxygen concentrator and cannula at least 6.5 feet (2 m) from hot, sparking objects or naked sources of flame.  
Electric Shock Hazard. Only qualified Drive DeVilbiss Healthcare homecare providers may remove the cabinet.

4. Attach the appropriate oxygen accessories (oxygen tubing or humidifier) to the oxygen outlet port.

**NOTE**– A maximum of 50 feet (15 meters) of tubing plus 7 feet (2.1 meters) of cannula plus a bubble humidifier is allowed between the concentrator and the patient.



### WARNING

In order to prevent a fire propagating from the patient through the cannula towards the unit, a means of protection should be located as close to the patient as practicable. Country Standards may vary. Please contact your provider for information.

## Oxygen Tubing Only Connection

1. Thread the cannula fitting onto the oxygen outlet port.
2. Attach the 5/32" (4 mm) I.D. oxygen tubing.

## Oxygen Tubing with Humidification Connection

If the physician has prescribed an oxygen humidifier as part of the patient's therapy, follow these steps (If using a prefill, go to Step 3.):

1. Fill the humidifier bottle per manufacturer's instructions.
2. Thread the wing nut located on the top of the humidifier bottle to the oxygen outlet port so that it is suspended. Make sure it is securely tightened.
3. Attach the 5/32" (4 mm) I.D. oxygen tubing, not to exceed 50 feet (15 meters) plus 7 feet (2.1 meters) of cannula, directly to the humidifier bottle outlet fitting.

**NOTE**– For optimum performance, the Drive DeVilbiss Oxygen Concentrator has a preset nominal output pressure of 20 psi (138 kPa). Use only "bubble-type" humidifiers designed for use with flows up to 10 liters per minute. Do not use "jet-type" humidifiers.



### WARNING

In order to prevent a fire propagating from the patient through the cannula towards the unit, a means of protection should be located as close to the patient as practicable. Country Standards may vary. Please contact your provider for information.

## When ready for operation

1. Attach the nasal cannula to the oxygen tubing (per the manufacturer's directions).
2. Follow the Operating Instructions.

## OPERATING INSTRUCTIONS

1. Remove the power cord completely from the strap. Make sure the power switch is in the "Off" position.
2. **120 Volt Units**– Insert the plug into an electrical outlet. The Drive DeVilbiss Oxygen Concentrator uses a two-prong polarized plug and is double-insulated to protect against electric shock.

**220/230/240 Volt Units** – Ensure cord is connected to the unit before inserting plug into an appropriate electrical outlet.



### WARNING

The plug on the Drive DeVilbiss 1025DS concentrators has one blade wider than the other. To reduce the risk of electric shock, this plug is intended to fit in a wall outlet only one way. Do not attempt to defeat this safety feature.

Improper use of the power cord and plugs can cause a burn, fire, or other electric shock hazards. Do not use the unit if the power cord is damaged.

Oxygen causes rapid burning. Do not smoke while your oxygen concentrator is operating, or when you are near a person utilizing oxygen therapy. Keep the oxygen concentrator and cannula at least 6.5 feet (2 m) from hot, sparking objects or naked sources of flame.



### WARNING

The Drive DeVilbiss 1025 oxygen concentrator is equipped with a fire mitigating outlet fitting that prevents propagation of fire into the unit. In order to prevent a fire propagating from the patient through the cannula towards the unit, a means of protection should be located as close to the patient as practicable. Country Standards may vary. Please contact your provider for information.

3. Press the power switch to the "On" position. When the unit is turned "On", all three lights (Service Required, Low Oxygen and Normal Oxygen) on the

## UNPACKING AND SETUP

front panel will illuminate momentarily and an audible signal will briefly sound confirming that the LEDs and audible signal are functioning properly. The unit will operate in "start up" mode with the Low Oxygen light lit until oxygen stabilization is achieved, at which time the Normal Oxygen light will come on and remain lit. The "start up" mode may take up to 15 minutes.

**NOTE**— *DeVilbiss recommends for optimal service life that the Drive DeVilbiss Oxygen Concentrator to be operated for at least 30 minutes after it is powered on. Shorter periods of operation, operating in extreme temperature/humidity conditions or in the presence of contaminants, and/or handling and storage conditions outside those specified, may affect the long term reliable operation of the product.*

4. Slowly turn the flow meter knob until the flow meter ball is centered on the line next to the appropriate flow rate.

**NOTE**— *When the flow meter knob is turned clockwise, the flow decreases (and eventually will shut off the oxygen flow). When the knob is turned counter-clockwise, the flow increases.*

**NOTE**— *For prescriptions of 10 LPM, be sure the ball is centered on the 10 liter line; the ball should not touch the red line. Setting the flow higher than 10 may cause the oxygen purity level to drop.*

**NOTE**— *The low-flow alarm may activate if the flow meter ball is set below 2 lpm. The unit will continue to run; however, the Service Required light will come on accompanied by an audible alarm. Adjust the flow meter to your prescribed flow.*

**NOTE**— *Do not use a low-output flow meter with this concentrator.*

**NOTE**— *The unit may require up to 15 minutes for the oxygen concentration and flow rate to stabilize. The flow rate should be monitored and readjusted if necessary.*

5. The flow meter has a locking device. If it is necessary to preset and lock in the prescribed flow rate, tighten the set screw located on the hex nut just below the control knob using a 1/16" Allen bit. No adjustment can be made without loosening the set screw.
6. The Drive DeVilbiss oxygen concentrator is now ready for use.



## PATIENT ALERT SYSTEM

The Drive DeVilbiss Oxygen Concentrator patient alert system will detect unit component failure. This system is comprised of both visible and audible alerts which signal the patient if a malfunction should occur.

### DeVilbiss OSD® Operation

The OSD is a device within Drive DeVilbiss concentrators that monitors the oxygen produced by the unit. The OSD operates as follows:

- Normal Oxygen (green light) - oxygen purity normal
- Low Oxygen (yellow light) - oxygen purity low—requires servicing

**NOTE**— If the oxygen purity continues to fall, an audible signal will sound intermittently. If the oxygen purity continues to fall to a low enough level, the yellow “Low Oxygen” light will remain on and the red “Service” light will also turn on.

**NOTE**— Refer to the Alerts section below for specific alert settings.

**NOTE**— After power on, the electronics continuously monitors the oxygen sensor. If a fault is detected, the green “Normal Oxygen” light will turn off and the beeping audible alert and blinking red “Service Required” light will activate.

The first 15 minutes, the unit will be in “Start Up” mode. The oxygen purity is continuously monitored and the green “Normal Oxygen” light will turn on as soon as the therapeutic oxygen levels are obtained. After 15 minutes stabilization time, if the O<sub>2</sub> is less than 85% the yellow Low O<sub>2</sub> LED will be on and a beeping audible alarm will occur. If the level is below 60% (after startup) then the yellow and red LEDs will be lit along with a beeping audible alarm. The audible low O<sub>2</sub> alarms are blocked during the 15 minute stabilization delay and also during the 10 minute stabilization delay that occurs during turn-down mode enter/exit.

### Alerts:

There are two visible service alerts located on the front panel.

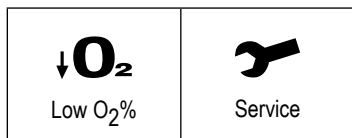

The audible alert system is internally powered; no batteries are required. If the indicator lights illuminate or the audible alert sounds other than during start-up, a problem has occurred

- Power Failure (Pulsing audible alert)
- Low Flow (Below 2 lpm) (Continuous red “Service” light and audible alert)

#### Below normal O<sub>2</sub>:

- The yellow Low Oxygen light will illuminate with an audible alarm at approximately <85%.
- The yellow Low Oxygen and red Service Required lights will illuminate with an audible alarm at <60%.

The audible alert will activate for a minimum of two minutes in a no power situation. There is no visual indicator for this alarm. If the unit is turned “On” without power or power is removed later, the alert will sound within 10 seconds. After that time, the alert will produce an audible pulse every few seconds. Power for this alert is provided by a capacitor on the PC board.

**NOTE**— If the concentrator has been unused for an extended period, the unit must run several minutes before the power fail alert will activate.

The PC (printed circuit) board is responsible for controlling the system and alerts.

**NOTE**— A high pressure condition is indicated by the audible (a “popping” sound) release of pressure from a pressure relief valve located on the compressor head.

**NOTE**— Settings below 2 LPM may activate the low flow alarm. Do not use a low-output flow meter with this concentrator.

## ALARM FUNCTION TESTING

The 1025 series is designed to activate alarms when certain conditions or failures occur. The alarm functions may be tested following the procedures below:

1. Overheating:
  - a. Remove the front and rear covers from the concentrator; then disconnect the cooling fan from the printed circuit board.
  - b. Replace the front and rear covers.
  - c. Place the concentrator in a location that has an ambient temperature of approximately 70° F. Then plug the unit into the appropriate mains voltage and turn it on.
  - d. Allow the unit to operate until the Service Required Alarm activates, which should be within approximately two hours.
2. Compressor Failure:
  - a. Remove the rear cover from the concentrator; then disconnect the compressor electrical connector from the main wire harness.
  - b. Plug the unit into the appropriate Mains voltage and turn it on.
  - c. Allow the unit to operate until the Service Required Alarm activates, which should be within approximately two minutes.
3. Low Flow / Obstruction of Gas Pathway:
  - a. Plug the concentrator into the appropriate mains voltage and turn it on.
  - b. Allow the device to run for several minutes.
  - c. Turn the flow meter off so that there is no oxygen flowing out of the unit.
  - d. Allow the unit to operate until the alarm condition occurs (red light and audible beep).
  - e. Increase the flow to 2 LPM and confirm that the alarm condition ends.
4. High Flow
  - a. Connect the oxygen concentrator to AC power and turn the power switch on.
  - b. Allow the device to run for several minutes.
  - c. Adjust the output flow to more than 11.0 LPM using the flow meter knob (turn counter clockwise until ball goes above 11.0 LPM).
  - d. The alarm condition (yellow light) should occur.
  - e. Decrease the flow to 10 LPM and confirm that the alarm condition ends.
5. Oxygen Generation Mains Failure:
  - a. Plug the concentrator into the appropriate mains voltage and turn it on.
  - b. Turn the flow meter to 10 LPM.
  - c. Attach another flow meter to the auxiliary oxygen port which is located on the rear of the concentrator and then adjust the flow to 3 LPM.
  - d. Allow the unit to operate until the Service Required Alarm is activated, which should be within approximately thirty minutes.
6. Pressure Failure:
  - a. Remove the front and rear covers from the concentrator.
  - b. Disconnect the tubing from the top of one of the sieve beds.
  - c. Plug the unit into the appropriate mains voltage and turn it on.
  - d. Turn the flow meter to 10 LPM.
  - e. Allow the unit to operate until the Service Required Alarm is activated, which should be within approximately thirty minutes.
7. Power Supply Failure
  - a. Connect the oxygen concentrator to AC power and turn the power switch on. Allow the device to run for several minutes.
  - b. With the power switch in the on position, unplug the AC power cord from the outlet.
  - c. The alarm condition (audible beep) should occur and continue for a minimum of 120 seconds. There is no visual indicator for this alarm



- condition.
- d. Reconnect the AC power cord and confirm that the alarm condition ends.
- 8. Malfunction – O2S Gas Temperature High
  - a. This alarm condition is tested automatically during start-up.
- 9. Malfunction – Corrupted Settings
  - a. This alarm condition is tested automatically during start-up.
- 10. Malfunction – Non-Recoverable Valve Error
  - a. This alarm condition is tested automatically during start-up.
- 11. Malfunction – O2S Oxygen Sensor Communication Failure
  - a. This alarm condition is tested automatically during start-up.
- 12. Low Oxygen Concentration – Startup Period
  - a. Connect the oxygen concentrator to AC power and turn the power switch off.
  - b. Leave the device off for several minutes until the outlet flow is zero (flow meter ball at zero).
  - c. Turn the power switch to the on position. The alarm condition (yellow light) occurs during startup until the oxygen concentration reaches 85%.
- 13. Low Oxygen Concentration – Startup Period Over
  - a. This alarm condition is tested automatically during start-up. Once the oxygen concentration reaches 85% the green light comes on.

## SERVICE LIFE

The expected service life of the 1025 is 5 years of operation, when used in accordance with all manufacturer guidance for safe use, maintenance, storage, handling and general operation. Expected service life of the unit, and in particular the sieve beds and compressor, may vary based on the operating environment, storage, handling and the frequency and intensity of use.

## ROUTINE PATIENT MAINTENANCE

DeVilbiss recommends using only original DeVilbiss parts and filters in order to guarantee a reliable operation of the product.

The oxygen patient should perform the following maintenance:

### Cannula, Tubing, and Humidifier Bottle

The patient should clean and replace the cannula, tubing, and humidifier bottle according to the manufacturer's instructions.

### Air Filter

The air filter should be inspected periodically and cleaned as needed by the user or caregiver. Replace if torn or damaged. To clean, follow these steps:

**NOTE**– Frequency of inspection and cleaning of filter may be dependent upon environmental conditions like dust and lint.

1. Remove the air filter located in the door on the back of the unit.
2. Wash in a solution of warm water and dishwashing detergent.
3. Rinse thoroughly with warm tap water and towel dry. The filter should be completely dry before reinstalling.



### CAUTION

Do not attempt to operate the unit without the air filter or while the filter is still damp

**NOTE**– The air filter should be monitored more closely in environments with abnormal amounts of dust and lint.



### CAUTION

Operation of the Drive DeVilbiss Oxygen Concentrator in extreme environments or without the air filter will prematurely occlude the intake bacteria filter and cause a decrease in the unit performance.

## Exterior Cabinet

The patient should clean the concentrator exterior cabinet weekly by using a damp cloth or sponge with a mild household cleaner and wiping it dry.



### WARNING

Do not apply liquids directly to the cabinet or utilize any petroleum-based solvents or cleaning agents.

## PERIODIC HOMECARE PROVIDER PREVENTATIVE MAINTENANCE

Use only DeVilbiss concentrator replacement parts and accessories.

Every Drive DeVilbiss Oxygen Concentrator is tested at the factory. To assure continued trouble-free performance, the following preventative maintenance should be performed by the homecare provider during periodic oxygen patient visits. Failure to properly maintain the unit will void the warranty.

1. Check the oxygen concentration with an oxygen analyzer (part #R217P62) – every 3 years.
  - a. Calibrate the oxygen analyzer prior to checking the oxygen concentration. The analyzer should be properly calibrated using the manufacturer's recommended procedure.
- NOTE**– Changes in temperature, altitude or humidity may affect the analyzer's oxygen concentration reading. The analyzer should be calibrated in similar conditions to the location of the concentrator.
  - b. Power the unit. Set the flow meter to 10 LPM and connect the analyzer to the unit's oxygen outlet port.
  - c. Wait 20 minutes for the display to stabilize. The concentrator must operate for a minimum of 20 minutes before checking the oxygen concentration.
  - d. Record the reading.
2. Check the audible alert and indicator lights during every service. When the power is turned "ON," listen for the audible alert and check to see if the front panel indicator lights are operating.
3. Inspect cabinet air filter (part #303DZ-605) every PM check. Replace if filter is torn or damaged.
4. Inspect intake bacteria filter (part #1025D-605) at every PM check. Replace if the filter looks dirty or there is a drop in oxygen purity.
  - a. Open the filter door and replace filter as required.

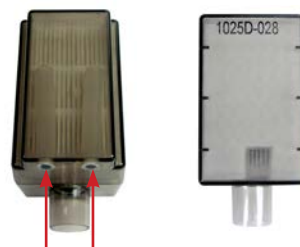

Air Intake Holes

5. Inspect the final bacteria filter (part #PV5LD-651) during every compressor service.



- a. Use the Cabinet Removal instructions found under CABINET REMOVAL in this manual to remove and attach the cabinets.
- b. Remove the hose from each end of the filter and discard the filter.

- c. Install the new final bacteria filter with the "IN" fitting toward the flow meter.
6. Inspect the compressor filter (part #1025D-682) during every compressor service. Replace if the compressor is replaced.
- NOTE**– A new style compressor filter with an aluminum housing is now being used. See below:



New Style



Old Style (no longer used)

7. Inspect the AC power cord, power switch and circuit breaker between every patient change. Replace any damaged or defective components.

**NOTE**– This PM Schedule reflects:

- 4000 hour usage equal to one year
- a normal, clean operating environment.

The homecare provider is responsible for:

- determining the condition of the concentrator operating environment.
- determining a preventative maintenance interval frequency\* which takes into consideration the specific operating environment.

\* Standard intervals are noted below. Service interval may be more or less frequent than stated below provided that the Home Care Provider establishes and documents appropriate protocols.

## PREVENTATIVE MAINTENANCE SUMMARY

### Patient / Caregiver

Clean and replace oxygen tubing, cannula / mask, and humidifier bottle (if used) according to manufacturer's instructions.

### Homecare Provider

#### During each inspection

Wash/Replace cabinet filter.

Check audible alert and indicator lights.

#### During each PM check – every 3 years for the 1025 series

Inspect/Replace intake bacteria filter as necessary.

Check oxygen purity.

#### During compressor service

Inspect/ Replace final bacteria filter.

Inspect/ Replace the compressor filter

**NOTE**– There is no portion of the gas pathways through the concentrator that could be contaminated with body fluids under normal conditions.

The device patient connection may unintentionally become contaminated with expired gases if a hose internal to the device becomes disconnected. This condition will cause no flow out of the device and/or an alarm condition. Should this occur, remove the front cabinet in order to determine where the disconnection occurred.

Replace all components from the free end of the disconnect through the outlet port. Reference the pneumatic diagram and replacement part numbers/ instructions.

## PROVIDER'S NOTES - Cleaning and Disinfection When There is a Patient Change

DeVilbiss Healthcare recommends that at least the following procedures be carried out by the manufacturer or a qualified third party between uses by different patients.

**NOTE**– If the following described complete processing of the concentrator by an appropriately trained individual is not possible, the device should not be used by another patient.

**NOTE**– If preventive maintenance is due at this time, these procedures should be carried out in addition to the servicing procedures.

1. Use disinfectants safely. Always read the label and product information before use.
2. Always wear personal protective equipment when performing this procedure. Use suitable gloves and safety glasses. Cover exposed skin on arms to prevent accidental contact with bleach solution that has been applied to the concentrator.
3. Dispose of all accessories that are not suitable for reuse. This includes but may not be limited to the oxygen tubing, tubing connectors, nasal cannula and/or mask, oxygen outlet connector, and humidifier bottle.
4. Clean the exterior of the concentrator with a clean lint-free cloth. Heavy soil should be removed with a clean lint-free cloth dampened with water. A soft bristled brush dampened with water can be used to remove stubborn soil. Dry the concentrator using a clean lint-free cloth if water was used to remove soil.
5. Use 5.25% chlorine bleach (Clorox Regular Liquid Bleach or equivalent). Mix one (1) part bleach with four (4) parts water in an appropriate clean container. This ratio produces a one (1) part bleach to five (5) total parts solution (1:5). The total volume (amount) of solution required is determined by the number of concentrators in need of disinfection. **NOTE**– An alternate suitable disinfecting agent (e.g. Mikrobac® forte or Terralin® Protect) may also be used. Follow disinfectant manufacturer's instructions.
6. Apply the bleach solution in an even manner to the cabinet and power cord using a clean lint-free cloth. The cloth should be dampened only and not dripping of solution. Do not use a spray bottle to apply the solution. Do not saturate the device with the solution. Take care that no solution enters the vent areas on the concentrator base or the Auxiliary O2 fitting area on the back of the unit. Avoid over-saturating the cabinet seams so that no solution residue builds up in these areas. Avoid the caster wells located on the bottom of the unit.
7. Exposure time of the disinfectant solution should be 10 minutes minimum to 15 minutes maximum.
8. After the recommended exposure time, all surfaces of the concentrator should be wiped with a clean lint-free cloth dampened with drinking quality water no warmer than room temperature. Dry the unit with a dry, clean lint-free cloth. This is to remove residue that may stain or leave a film on the unit, especially after repeated disinfections.
9. Check the cord, the plug on the back of the device, the power switch, the fuse holder, and the indicator lights for possible damage. Replace all damaged or worn components.
10. Replace the cabinet air filter on the back of the device.
11. Check the oxygen concentration. If the device is within specification, the extended life intake bacteria filter does not need to be replaced between patients. If the oxygen concentration is not within specification, the provider should refer to the service manual section on Troubleshooting.
12. OPTIONAL INSIDE CLEANING: The concentrator must be disconnected from the power supply for this step: Open the concentrator and remove all dust deposits inside the cabinet with an appropriate vacuum cleaner. Close the concentrator.

# MAINTENANCE

**NOTE**– There is no portion of the gas pathways through the concentrator that could be contaminated with body fluids under normal conditions.

The device patient connection may unintentionally become contaminated with expired gases for a single fault condition i.e., a hose internal to the device becomes disconnected. This condition will cause no flow out of the device and/or an alarm condition. Should this occur, refer to the service manual for additional instructions.

## Cleaning

	Recommended cleaning interval	Number of cleaning cycles *	Compatible cleaning method
Outer Cabinet	7 days	260	Water, use only a damp cloth
Air Filter	7 days	104	Mild dish soap and warm water

\* number of cleaning cycles determined by recommended cleaning interval and expected service life

## Disinfection

**NOTE**– The disinfection process can only be completed by the manufacturer or by a qualified Drive DeVilbiss provider/service technician.

	Recommended disinfection interval	Number of disinfection cycles *	Compatible disinfection method
Cabinet, power cord	Between patients	20	Microbac Forte or Terralin <sup>®</sup> , 1:10 chlorine bleach (5.25%) and water solution
Oxygen tubing, tubing connectors, nasal cannula/ mask, oxygen outlet connector, humidifier bottle, cabinet air filter	Do not clean, replace between patients	N/A	N/A
Optional - Inside cabinet	Between patients	N/A	Remove dust with a vacuum cleaner

## SYSTEM OPERATION

The Drive DeVilbiss Oxygen Concentrator uses a pressure swing adsorption system. The air is drawn into the unit through air filters and into a double-head compressor.

A pneumatic diagram of the system is shown on page 29.

The compressed air passes through a rotary valve, which is cycled at a pre-determined rate, and is directed into one of two sieve beds. The sieve beds contain molecular sieve material which is a synthetically-produced inorganic silicate. It is very porous and has the unique ability to selectively adsorb nitrogen from the air as it passes through the sieve bed.

As one bed is being pressurized, the other bed is quickly depressurized. This allows the nitrogen that was adsorbed during its pressurization cycle to be exhausted from the sieve material.

The nitrogen is released through an exhaust port located on the rotary valve assembly. The port is connected to the exhaust muffler.

Also during each bed pressurization, a small amount of oxygen flows through an orifice from the pressurized bed into the depressurizing bed. This helps purge the nitrogen from the depressurizing bed.

The beds will continue to be alternately pressurized and depressurized as the unit operates.

Oxygen leaving the sieve beds is directed through a check valve to the accumulator tank. A pressure regulator on the tank controls the oxygen pressure as it leaves the accumulator and enters the flow meter. The flow meter allows the oxygen flow to be controlled and adjusted to the level prescribed by the patient's physician. From the flow meter the oxygen passes through the final bacteria filter and finally the oxygen outlet port to the patient.

The Drive DeVilbiss Oxygen Concentrator operates on a timed cycle (2.5 sec. @ flows > 4.5 LPM) that is controlled by the PC board. The PC board will send voltage to the valve causing it to shift and alternately pressurize the sieve beds.

The PC board also activates the electronic alert system. Low flow, system abnormality, and power failure are indicated by audible and visible alerts. A high pressure condition will be indicated with a "popping" type sound produced by release of pressure from a pressure relief valve on the compressor head.

The 1025 operating system incorporates "turn-down" technology. The PC board constantly monitors the flow rate and will decrease the cycle time whenever the flow rate is equal to or less than 4.5 LPM. Therefore it "turns-down" the cycle based on lower oxygen demand. As a result, the unit runs cooler and less power is consumed.

## NORMAL OPERATING SEQUENCE

When the concentrator is turned "On," the following cycling sequence can be observed by attaching a pressure gauge to the accumulator tank test point.

1. The rotary valve is quickly cycled several times to relieve residual bed pressure preventing a static condition in the compressor. This rapid cycling only happens on start-up and is clearly heard as pressure is being quickly exhausted several times. The pressure exhausts through an exhaust muffler that is connected to the valve.
2. The PC board applies a short DC voltage signal to the valve. The valve will stop for several seconds causing the right bed to pressurize first while the left bed depressurizes.
3. Voltage is again applied to the valve for a short time. The valve will stop for approximately a second. During this time the sieve bed pressures are equalized.
4. A short DC voltage signal is again applied to the valve. The valve will stop for several seconds causing the left bed to pressurize while the right bed depressurizes.
5. A short DC voltage signal is again applied to the valve. The valve will stop for approximately a second. During this time, the sieve bed pressures are equalized.
6. The cycle then repeats with step 2.

**NOTE**— *In the "turn-down" mode, the fixed cycle time is decreased to less than 2 seconds.*

# TROUBLESHOOTING

## SIMPLIFIED TROUBLESHOOTING

The key to simple troubleshooting is to recognize which type of problem exists and select the most effective approach to solving the problem. The different types of problems and the approaches for solutions are as follows:

### Type I— Purity Issues (Low Purity Indicator Light is activated and the audible alert may also sound.)

**WARNING**  
 Electric Shock Hazard. Extra care should be taken if it is necessary to operate the unit with the cabinet removed.

**WARNING**  
 Mechanical Hazard. Keep fingers, loose clothing, etc. away when working on compressor.

Observe the pressure cycle at the oxygen tank.

1. Connect a calibrated pressure gauge to the unit's oxygen tank test point or manifold. See accumulator pressure test on page 17.
2. Set the unit's flow meter to 10 LPM.
3. Power the unit and allow it to operate for a minimum of 5 minutes before observing the pressure cycle.
4. Compare the high pressures and low pressures to those expected for the current elevation and use the following chart to find the appropriate action. All consecutive high pressures should be within 2 psi of each other and all consecutive low pressures should be within 2 psi of each other.

**NOTE**— For normal system pressures refer to Specifications.

**NOTE**— Check for leaks using a certified leak detection solution such as Snoop® or equivalent (must not contain ethylene glycol). Apply leak test solution to all fittings and hose connections with unit running. If an air leak is present, the solution will bubble. All leaks should be repaired before putting the unit back in service.

**WARNING**  
 Do not apply leak test solution to any part of the rotary valve or the main PC Board assembly.

### Pressure Diagnostic Chart

If Pressure Reading Is	Do This	To This
Higher than expected (pressure relief valve may be activated)	Replace	Sieve beds (2)
Lower than expected	Inspect and replace, as needed	Filters
	Inspect and correct or replace, as needed	Tubing connections
	Troubleshoot	Compressor See Component Testing, Repair and Replacement
As expected	Inspect and correct, as needed	Leaks from sieve beds to oxygen outlet port
Dropping too low during cycle change	Replace	Check valves or manifold
Uneven - high pressures & low pressures are not consistent during cycle	Inspect and replace, as needed	Rotary valve wire harness
	Troubleshoot or replace	Rotary valve or PC board. See Component Testing, Repair and Replacement

### Type II—Operation Issues (Service Indicator Light. The audible alert may also sound and the pressure relief valve may be activated.)

**WARNING**  
 Electric Shock Hazard. Extra care should be taken if it is necessary to operate the unit with the cabinet removed.

**WARNING**  
 Mechanical Hazard. Keep fingers, loose clothing, etc. away when working on compressor.

**NOTE**— Check for leaks using a certified leak detection solution such as Snoop® or equivalent (must not contain ethylene glycol). Apply leak test solution to all fittings and hose connections with unit running. If an air leak is present, the solution will bubble. All leaks should be repaired before putting the unit back in service.

**CAUTION**  
 Do not apply leak test solution to any part of the rotary valve or the main PC Board assembly.

### Operation Alarm Chart

If this is happening	It's because of this	Do this to resolve
Pressure relief valve has a 'popping' noise with possible uneven tank pressure.	Rotary valve not cycling properly.	Test rotary valve. Refer to page 25.
Continuous red light with a pulsing audible alert while compressor is operating.	Low flow alert – flow setting below 2 lpm.	Correct setting and educate user.
Continuous red light with a continuous audible alert and unit is warm to touch.	Internal temperature is too high.	Move unit to cooler location.
		Ensure unit vents are clear.
		Ensure unit filters are clean.
Continuous red light with a pulsing audible alert and fan is operating but compressor is not.	Internal power failure to compressor.	Ensure cooling fan is operating, replace as needed.
		Ensure there is proper voltage to the unit. If voltage is correct, replace capacitor or compressor.
Pulsing audible alert and compressor and fan not operating.	External OR Internal power failure.	Test voltage at compressor connector. If no voltage, replace main wire harness. If voltage present, replace capacitor or compressor.
		Ensure voltage is correct and / or the part is functional for the following: AC outlet, power cord, IEC connector or cord connection, main wire harness, circuit breaker; correct as needed. If issue persists, replace power switch.
Pulsing audible alert and compressor is operating but fan is not.	Internal power failure at fan wire harness or PC board.	Inspect wire harness and replace harness or PC board as needed.

### Type III—The concentrator runs and continues to cycle but has low oxygen concentrations and no alarms are activated.

This problem is similar to Type I in the way it is diagnosed/resolved. Observe pressure cycle at oxygen tank as recommended in Type I.

# TROUBLESHOOTING

## TROUBLESHOOTING CHART A

Visible Alarm	Audible Alarm	Compressor
OFF	OFF	ON
OTHER SYMPTOMS	POSSIBLE CAUSE	POSSIBLE REMEDY
Pulsating air noise	Intake filter not in place or defective	Check filter and replace if necessary
	Compressor intake hose disconnected	Reconnect hose
Excessive noise	Loose or defective motor mounts	Replace motor mounts
	Mounting plate loose	Reinstall or replace mounting plates
	Defective compressor	Replace compressor
	Defective cooling fan	Replace cooling fan
Fluctuating oxygen flow	Occluded humidifier	Clean or replace humidifier
	Use of improper humidifier	Use only a bubble-type humidifier designed for use with flows up to 10 liters per minute and 20 psi pressure
	Occluded filters	Clean or replace filters
	Occluded or defective cannula and tubing	Detach cannula from oxygen delivery tubing. If proper flow is not attained, check tubing for kinks or other obstructions. Clean or straighten as required or replace tubing if necessary
	Use of excess oxygen tubing	The unit is designed to deliver 10 lpm with a cannula on 50 feet (15 meters) of approximately 5/32" (4 mm) inside diameter tubing. Smaller diameter tubing or the addition of any other flow restriction may prevent obtaining the desired flow rate.
	Defective flow meter	Replace flow meter
	Leak in system	Check for leaks in all hoses and fittings
	Defective compressor	Replace compressor
	Defective compressor reed valve	Replace compressor reed valve
	Defective check valve	Replace check valve or manifold
	Pressure regulator not adjusted properly or defective	Adjust or replace pressure regulator
Little or no oxygen flow	Flow meter not adjusted properly	Adjust flow meter
	Hose disconnected to flow meter	Reconnect hose
	Oxygen delivery tubing is kinked or blocked	Straighten tubing or remove obstruction
	Occluded humidifier	Clean or replace humidifier
Low oxygen concentration	Leak in system	Check for leaks in all hoses and fittings
	Defective sieve bed check valve	Replace check valve or manifold
	Defective compressor reed valve	Replace compressor reed valve
	Defective compressor	Replace compressor
	Rotary valve not operating correctly	Replace valve
	Occluded filters	Clean or replace filters
Audible alarm does not sound during power failure	Unit has not been used for an extended period of time. <b>NOTE</b> —If the concentrator has been unused for an extended period, the unit must run several minutes before the power fail alarm will activate.	Allow unit to run for 20 minutes and retry
	Defective PC board	Replace PC board
	Defective power switch	Replace power switch
	Defective wire harness	Replace wire harness
Audible alarm does not sound when unit is turned "On"	Defective PC board	Replace PC board
Pressure relief valve activated "popping" sound	PC board connectors not properly latched	Be sure tabs are pushed completely into place
	Defective PC board	Replace PC board
	Defective rotary valve	Replace valve
Service Required light does not illuminate when unit is turned "On"	PC board connectors not properly latched	Be sure tabs are pushed completely into place
	Defective PC board	Replace PC board



# TROUBLESHOOTING

## TROUBLESHOOTING CHART B

Visible Alarm		Audible Alarm		Compressor	
Blinking		Pulsing		OFF	
OTHER SYMPTOMS	POSSIBLE CAUSE		POSSIBLE REMEDY		
Fan off	Line cord not properly installed or defective		Insert plug in receptacle or replace line cord. On 220/230/240 Volt units, check that the IEC connector on the back of the unit is attached.		
	No power at receptacle		Check building circuit breaker or fuse, or have house wiring checked by qualified electrician. Circuit may be fully loaded with other appliances and another receptacle may be required.		
	Oxygen concentrator circuit breaker activated		Press the circuit breaker reset button. If unit circuit breaker opens again, check internal wiring.		
	Line cord quick-connect terminal inside unit is disconnected		Reconnect quick-connect terminal		
	Defective power switch		Replace power switch		
	Defective circuit breaker		Replace circuit breaker		

## TROUBLESHOOTING CHART C

Visible Alarm		Audible Alarm		Compressor	
Blinking		Pulsing		ON	
OTHER SYMPTOMS	POSSIBLE CAUSE		POSSIBLE REMEDY		
Fan and compressor operating Pressure relief valve activated – “popping” sound	Connector on PC board not connected		Connect connector		
	Defective PC board		Replace PC board		
	Defective valve or valve wire harness		Replace valve or valve wire harness		

## TROUBLESHOOTING CHART D

Visible Alarm		Audible Alarm		Compressor	
ON		ON		OFF	
OTHER SYMPTOMS	POSSIBLE CAUSE		POSSIBLE REMEDY		
Fan operating	Main wiring harness disconnected/defective		Reconnect/replace wiring harness		
	Loose compressor wire		Tighten or attach wire		
	Defective capacitor		Replace capacitor		
	Defective compressor		Replace compressor		
Unit warm to the touch and cannot be restarted for several minutes	Compressor overheated due to:		1. Clean or replace filters		
	1. Occluded filters		2. Remove obstruction		
	2. Restricted input or output air passage		3. Check line voltage; use alternate circuit independent of other appliances		
	3. Low or high line voltage				
	Defective cooling fan		Replace cooling fan		
	Defective compressor		Replace compressor		

# TROUBLESHOOTING

## TROUBLESHOOTING CHART E

Visible Alarm	Audible Alarm	Compressor
ON	ON	ON
OTHER SYMPTOMS	POSSIBLE CAUSE	POSSIBLE REMEDY
Fluctuating or no flow	System pressure below 20 psi (138 kPa) due to:	
	1. Leak in system	1. Check for leaks in all hoses and fittings
	2. Defective compressor	2. Replace compressor

## TROUBLESHOOTING CHART F

Visible Alarm	Audible Alarm	Compressor
See Below	See Below	ON
OTHER SYMPTOMS	POSSIBLE CAUSE	POSSIBLE REMEDY
No OSD lights are illuminated.	Defective OSD/PC Board.	Check concentration with an oxygen analyzer. If the concentration is within specification, replace the PC board.
Yellow Low Oxygen Light and the Red Service Required Light are illuminated accompanied by a beeping audible alarm	Oxygen level is low*	Check concentration with an oxygen analyzer. If the concentration is within specification, replace the PC board. If the concentration is low, refer to low oxygen concentration symptom in Troubleshooting Chart A.
Red Service Required light is illuminated with beeping audible alarm.	Defective OSD	Replace PC board.
Yellow Low Oxygen light is illuminated.	Oxygen level is low*	Check concentration with an oxygen analyzer. If the concentration is within specification, replace the PC board. If the concentration is low, refer to low oxygen concentration symptom in Troubleshooting Chart A.
Yellow Low Oxygen light is illuminated and an intermittent audible alarm sounds every few seconds.	Oxygen level is low*	Check concentration with an oxygen analyzer. If the concentration is within specification, replace the PC board. If the concentration is low, refer to low oxygen concentration symptom in Troubleshooting Chart A.

\*Refer to Alerts page for oxygen purity levels.

**NOTE**-If unit does not run or perform to specification, verify the proper AC input voltage and frequency are being used.

## PROPER REPAIR PROCEDURES



### WARNING

When servicing the Drive DeVilbiss Oxygen Concentrator, be absolutely certain that the correct tools are used and that the parts are free of oil and grease or any material not compatible with oxygen. Teflon® tape is recommended and must be applied to the male threads omitting the first thread to eliminate the possibility of tape particles entering the oxygen system.

Electric shock hazard. Do not remove cabinet. The cabinet should only be removed by a qualified Drive DeVilbiss homecare provider. Disconnect the power cord from the wall outlet before attempting repairs on the unit. Extra care should be taken if it is necessary to operate the unit with the cabinet removed.

**NOTE**– Be sure to read all of the steps involved before beginning any of the procedures in this manual.

**NOTE**– After repairing or replacing a component, run the unit for 20 minutes, check the oxygen concentration and test for leaks.

The DeVilbiss Oxygen Concentrator is designed for ease of service. To aid service personnel a Service Kit (part #444-501) is available which contains the necessary gauges, tools, and testing instruments to properly service the oxygen concentrator. See list below.

In addition, you will also need an oxygen analyzer (part #R217P62) to periodically check oxygen concentration levels and leak test solution.

### The following parts are included in the Service Kit:

1	Slotted bit
1	#1 Phillips bit
1	#2 Phillips bit
1	Crescent wrench
1	8" Duckbill pliers
1	Voltmeter
2	Pressure/Vacuum gauge
1	Tool box
2	Test Fittings
1	Torx screwdriver w/bits
1	Channel Lock Pliers
1	1/4" Ratchet wrench
1	10mm Socket 1/4" Drive
1	1/4" Drive extension
1	Plastic storage case

## CABINET REMOVAL

The majority of all the servicing and repairs can be done without removing the front cabinet completely. However, it may be loosened or removed to gain access to the components behind it.

### To remove back cabinet:

1. Unplug the unit from the wall outlet.
2. Remove the six screws that secure the back cabinet – 2 behind handle, 2 near the bottom, and 1 on each side.

**NOTE**– All six screws are the same size.

3. Remove the back cabinet by sliding it toward the rear until clear.
4. To reassemble, reverse steps 2-3.

### To loosen the front cabinet:

5. Remove the two screws (located directly above the intake bacteria filter) that hold the front cabinet to the unit's internal structure.
6. Remove the screw located near the bottom of the recessed humidifier compartment on the front of the unit. The top of the front cabinet can now be tilted forward to allow access to the components behind it.

### To remove the front cabinet completely:

7. Tilt cabinet forward.
8. Before disconnecting the wires from the power switch and circuit breaker note their positions in order to reconnect them properly; then disconnect the wires.
9. Disconnect the hose at the bottom of the flow meter and remove cabinet.
10. To reassemble reverse steps 5 – 9 making sure bottom of cabinet is inserted securely in base of unit.

**NOTE**– Two types of cabinet screws are used in the 1025 models, thread-forming screws and machine screws. Do not overtighten the thread-forming screws; they should be torqued to 18 –20 in-lbs. The machine screws have much finer threads and are used in conjunction with brass inserts that are molded into the cabinet part; they should be torqued to 20 – 25 in-lbs.

When replacing a cabinet part such as the front cover, base or compressor box be sure to use the correct screw. The fine threaded machine screws should always be used if there is a brass insert. Thread-forming screws should be used if there is no brass insert molded into the cabinet part.

These screws are not interchangeable, so be sure to order the correct part number. See figure below.



## ACCUMULATOR TANK

The oxygen accumulator tank holds the concentrated oxygen and releases it to the patient at a specified liter flow.

## ACCUMULATOR PRESSURE TEST

### To check accumulator pressures:

1. Make sure the unit is "Off."
2. Use the Cabinet Removal instructions listed previously to open the unit for testing.
3. Use the pressure gauge (part #PVO2D-601) and pressure test assembly (part #303DZ-637) included in the Service Kit.

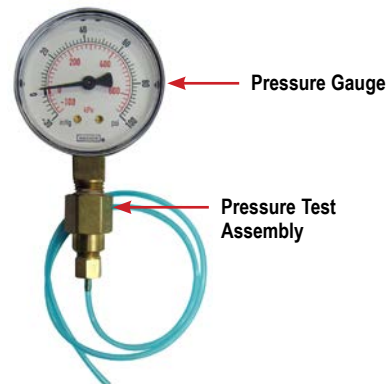

# COMPONENT TESTING, REPAIR AND REPLACEMENT

- Remove the tubing cap from the accumulator tank fitting or from the manifold attached to the tank, and attach the 1/16" (1.6 mm) diameter tubing from the gauge to the fitting just vacated above.  
See Figures below showing pressures being checked at accumulator tank "T" fitting and manifold.



Accumulator "T" Fitting



Manifold

- Turn the unit "On" with the flow rate set to maximum recommended flow, which is 10 lpm. Allow the unit to run for 5 minutes before observing the pressures. During each timed cycle, the average pressure in the oxygen accumulator will rise and fall. The high pressures should be consistent and the low pressures should be consistent. The pressure swing will be approximately 4-5 psi.

**NOTE**– Expected normal pressures observed depend on altitude and flow rate. See the Typical Peak Accumulator Tank Pressure Range chart below.

- Increases in altitude and flow rate will slightly decrease accumulator pressures.
- Lower altitudes and flow rates will slightly increase accumulator pressures.

**NOTE**– A defective check valve in the purge harness may cause a rapid drop in accumulator pressure below the minimum value.

TYPICAL PEAK ACCUMULATOR TANK PRESSURE RANGE @ 10LPM		
Altitude	Psi	kPa
0 to 457 m 0 to 1500 ft.	25-36	172-248
457 to 914 m 1500 to 3000 ft.	21-33	145-228
914 to 1524 m 3000 to 5000 ft.	21-30	145-207

- Refer to the Type 1 – Purity Issues, found under Simplified Troubleshooting, to determine the appropriate action to take in resolving abnormal pressure cycles.

**NOTE**– A defective compressor will be indicated by slowly rising pressure. Pressure may only reach a certain level and then stop.

Low oxygen concentration levels and accumulator pressures higher than normal may indicate defective sieve beds. Severely contaminated beds may also cause the pressure relief valve on the compressor to open.

**NOTE**– A malfunctioning rotary valve may also cause high accumulator tank pressure and activation of the pressure relief valve. In this case it should be determined whether the problem is with the sieve beds, valve, or both.

## AUXILIARY OXYGEN PORT

All 1025 series concentrators are manufactured with an auxiliary oxygen port located on the back of the unit.

### To fill oxygen cylinders:

This external port can be used to fill oxygen cylinders with an FDA-cleared cylinder filling device that is designed to use oxygen from a concentrator to fill a cylinder. The port is only for use with FDA-cleared filling devices with compatible oxygen input specifications. The flow meter should be set at 6 LPM or less when the concentrator is being used during cylinder fill. The

port does not affect concentrator performance if properly used. See figures below.

### Auxiliary Port Output Specifications:

Outlet Pressure ..... <15 psi  
 Outlet Flow ..... 2.0 LPM  
 Outlet Oxygen ..... >90%  
 Operation Time ..... Continuous

Refer to the cylinder filling device instruction guide for the oxygen input/output specifications, connection and operating instructions.

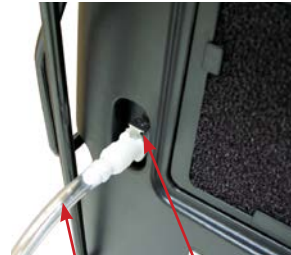

Transfill Hose (PF1100TUB) Auxiliary Port



Transfiller Caddy (525DD-650)



### WARNING

When using the Transfiller Caddy with a Transfill device, always keep the system on a flat surface. Disassemble the system prior to moving.

## CAPACITOR

The capacitor enables the compressor to start and run by supplying voltage to the windings of the compressor motor. A defective capacitor will result in the compressor running slower or not starting.



### CAUTION

The 1025DS concentrators use a GSE compressor with a 60 mfd capacitor. If replacement is necessary, be sure the correct capacitor is installed.



### CAUTION

The 1025KS/1025UK concentrators use a GSE compressor with a 17.5/15 mfd capacitor respectively. If replacement is necessary, be sure the correct capacitor is installed.



### WARNING

Electric Shock Hazard. When replacing the capacitor, do not touch the terminals or allow metal objects to come in contact with the terminals on the capacitor. The capacitor may hold a charge for several days after the unit is turned off.

If a defective capacitor is suspected, a new one must be installed. The capacitor is located beside the intake filter or next to the cooling fan in the base of the unit.

### To replace the capacitor:

- Make sure the unit is unplugged from the wall outlet.
- Remove the back cabinet and also loosen the front cabinet and tilt it forward. Use the cabinet removal instructions listed previously.
- Disconnect the two wires from the terminals on the capacitor.
- Cut the nylon cable tie holding the capacitor in place and remove the capacitor.
- Install the new capacitor and secure with a new cable tie.
- Reconnect the wires to the new capacitor.
- Replace both cabinets and secure with screws.



## CHECK VALVES / MANIFOLD

### Manifold And Sieve Bed Check Valves

The manifold check valves, located in the manifold attached to the accumulator tank, and the sieve bed check valves, located in the purge harness between the outlet of each sieve bed and the accumulator tank, allow oxygen to pass from the sieve beds to the accumulator tank when the bed pressure is greater than the accumulator tank pressure. These valves also prevent reverse flow of oxygen from the accumulator tank to the sieve beds.

The manifold also directs a small amount of pressurized oxygen into the discharging sieve bed to aid the nitrogen exhaust process. The purge harness includes a fixed orifice that performs the same function.

A defective manifold or sieve bed check valve will result in lower oxygen concentrations and accumulator pressures.

Use the Accumulator Pressure Test listed previously to troubleshoot manifold or sieve bed check valves.

- To replace a defective sieve bed check valve, remove the tubing on either side of it and install a new valve making sure the outlet end is toward the accumulator tank.
- To replace a defective manifold check valve, replace the manifold.

**NOTE**– Also see *Manifold* section on page 22.

## COMPRESSOR

The Drive DeVilbiss Oxygen Concentrator uses a double-head, oil-free compressor. The compressor is secured to the base with a mounting plate and four motor mounts.

### Pressure Relief Valve

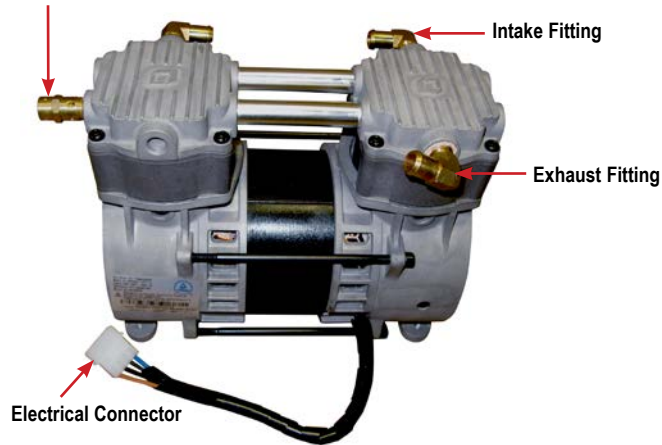

Changes were made to the original compressor in January, 2020. These changes include a redesigned valve plate and sleeve with heat sink. All 1025 models now have the updated compressor. See figures below.



(Updated compressor with redesigned valve plate and sleeve.)



Sleeve w/Heat Sink



Valve Plate

A compressor that is worn or defective may:

- cause pressure to rise slowly.
- cause excessive noise and/or vibration.
- cause lower oxygen concentrations.

A worn or defective compressor can be caused by a defective internal component such as:

- reed valve
- o-ring
- gasket
- cup seal

These components are included in the Compressor Rebuild Kit (1025D-643 and 1025K-643).

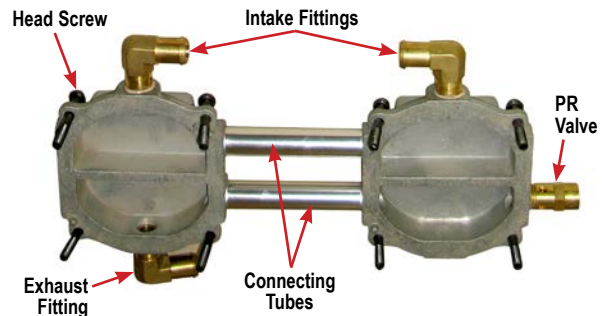
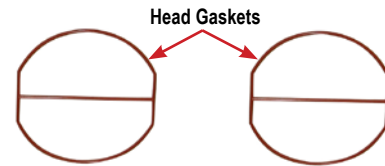
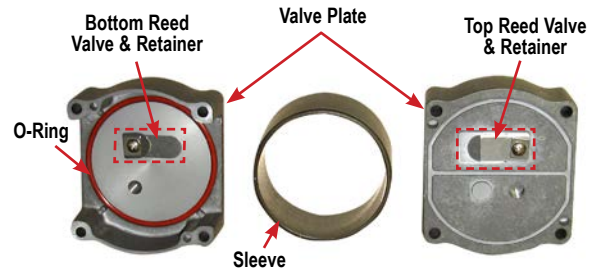
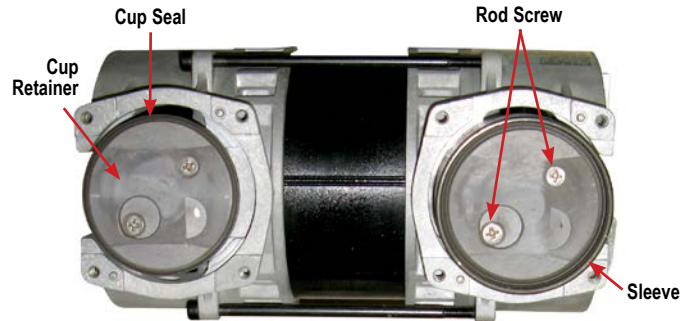

**NOTE**– A built-in thermal cutoff switch will shut the compressor off if it becomes overheated. This protects the compressor from damage caused by heat build-up. (Some models have an auxiliary thermostat mounted within the compressor compartment.) Should this condition occur, the compressor will require several minutes for the thermo-protective device to reset.

**NOTE**– A pressure relief (PR) valve is located on the pressure head to prevent high pressure build up in the system should a component malfunction occur.

## To test the compressor operating voltage:

The compressor requires line voltage to operate. If the compressor does not start when the unit is turned on, the voltage input must be tested:

1. This voltage can be checked at the compressor connector using an AC voltmeter or test light connected to the brown and blue wires. The voltmeter is the best way to test.



Testing Compressor Voltage

2. If no voltage is detected, disconnect power and check for loose or broken wires between the compressor connector and switch or wire harness.
3. If there is voltage at the compressor connector, then either the capacitor or the compressor itself is defective.

## To test the compressor for proper output:

**NOTE**— If the compressor is not providing a high enough output the patient alert system may be activated.

1. Use the Cabinet Removal instructions listed previously to open the unit for testing.
2. Use the Accumulator Pressure Test listed previously to observe the high pressures, low pressures and the pressure drop.
3. Refer to the Type 1 – Purity Issues, found under Simplified Troubleshooting, to determine the appropriate action to take in resolving abnormal pressure cycles.

**NOTE**— A compressor, which slowly builds pressure that remains below 25 psi, indicates worn cup seals and/ or reed valves.

## If these conditions are observed then:

- The unit filter(s) may be occluded—check the air filter, compressor filter, and intake filter for occlusions.
- There may be a severe leak in the system—check for air leaks using a leak detection solution such as Snoop® or equivalent (must not contain ethylene glycol).



### CAUTION

Do not apply leak test solution to any part of the rotary valve or the main PC Board assembly.

- The compressor reed valves, cup seal, or the compressor itself may be defective.

If the filters are not occluded and no leaks are found, the compressor must then be removed and repaired or replaced.

## To remove the compressor:

1. Make sure the unit is unplugged from the wall outlet.
2. Use the Cabinet Removal instructions listed previously to open the unit.
3. Disconnect the compressor wires by disconnecting the compressor electrical connector.
4. Remove compressor filter by loosening hose clamps and removing hoses from compressor exhaust fitting and heat exchange tube. This can be done using a 1/4" nut driver or flat screw driver.
5. Rotate heat exchange tube to the right 90°.
6. Disconnect intake hose from intake filter.
7. Carefully lean unit backwards slightly in order to access motor mount nuts on the bottom. Using a 10 mm nut driver or socket wrench remove the four motor mount hex nuts.
8. Place unit in upright position and carefully lift the compressor and mounting plate assembly out of the compressor box.



### CAUTION

If the unit has been running recently, the compressor may be hot.

9. Disconnect the intake hose from both intake fittings on compressor.

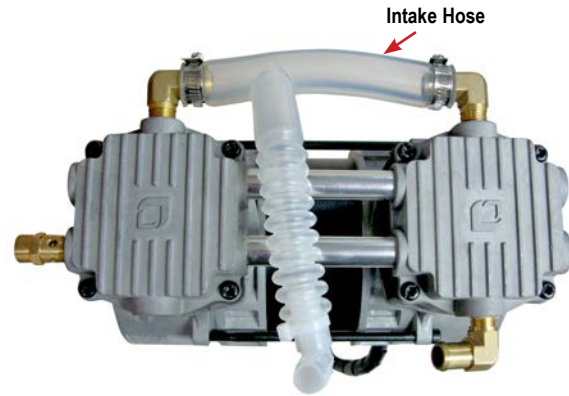

10. Turn compressor upside down and place on work surface.
11. Remove both retaining plates, one on each side of the compressor.

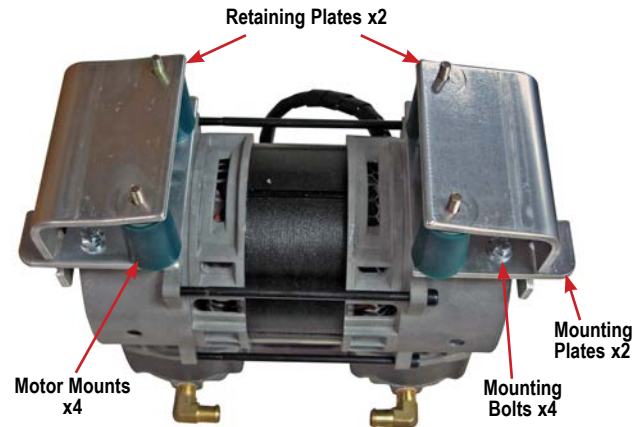

12. Inspect motor mounts to see if they are torn or damaged. If necessary, remove the motor mounts by unscrewing them from the mounting plates by hand. Install new ones; hand tighten only.

**NOTE**— If compressor is being replaced, mounting plates need removed. Use a 3/8" socket to remove mounting plate bolts.



## To inspect and/or replace internal components:

1. Place compressor upright and remove the eight screws that hold the compressor heads in place. When removing the heads, be sure to keep each head and its components with the correct compressor side.
2. Check for proper placement of or damage to the gaskets on the bottom of the compressor heads. Replace if damaged.

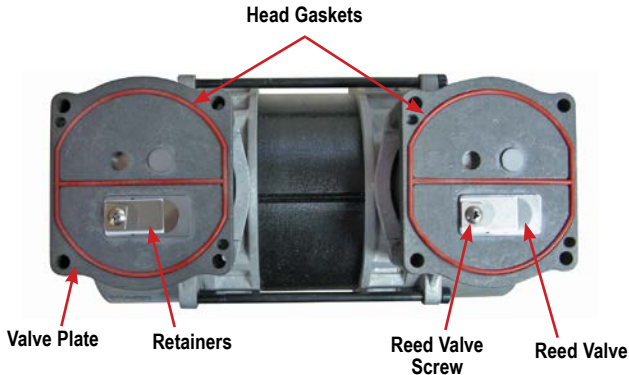

3. Remove reed valve plates. A reed valve is located on each side of the valve plate.
4. The compressor reed valves should be flush with the valve plate. If the valve is broken or not flush with the valve plate, or foreign matter is detected inside the head, clean or replace the compressor reed valves.

## To replace the compressor reed valves:

- a. Remove the screw holding the compressor reed valves in position on the valve plate and discard the used reed valves.
  - b. Position the new reed valves so that they are centered and completely cover the holes in the valve plate.
  - c. Place the metal retainers on the reed valves and secure with the reed valve screw.
5. Check for proper placement of or damage to the rubber o-ring on the bottom of the valve plate. Replace if damaged. Refer to the compressor rebuild kit pictures on page 19.
  6. Remove piston sleeves by pulling upward and inspect cup seal on pistons. Replace if badly worn or damaged.

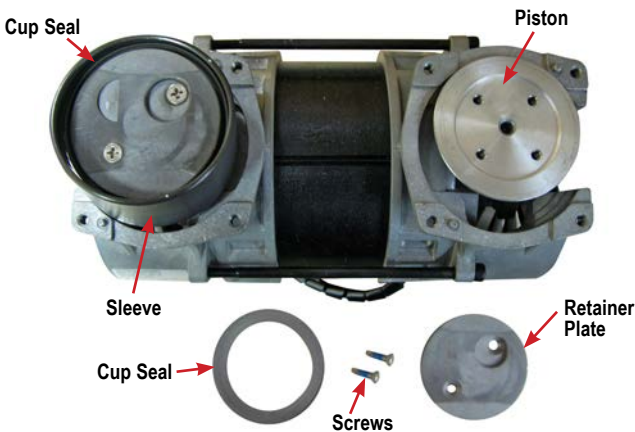

## To replace cup seal:

- a. Remove both rod screws from top of piston. Note the position of the screws since they are different lengths.
- b. Remove the cup retainer plate.
- c. Discard defective cup seal.
- d. Place new cup seal into position.
- e. Replace cup retainer plate.
- f. Secure with screws.

7. Clean inside surface of sleeves before reinstalling. Position sleeve at 45 degree angle over the piston. Carefully push it down as you rotate it slightly around the top of the piston until it is in place.
8. Place valve plates on the compressor so that heads of reed valve screws are aligned with the indentation in top of pistons.
9. Install the compressor heads so that the holes in the heads are aligned with the holes in the compressor housing.
10. Secure compressor heads with the screws.

## To replace the compressor:



### CAUTION

The 1025DS concentrators use a GSE compressor with a 60 mfd capacitor. The 1025KS/1025UK concentrators use a GSE compressor with a 17.5/15 mfd capacitor, respectively. If replacement is necessary, be sure the correct capacitor is installed.

1. Position mounting plates with hooks facing intake side of compressor and secure with four compressor mounting bolts.

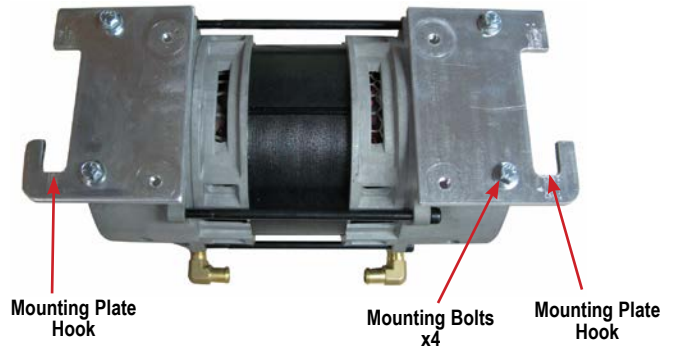

2. Install motor mounts and retaining plates.

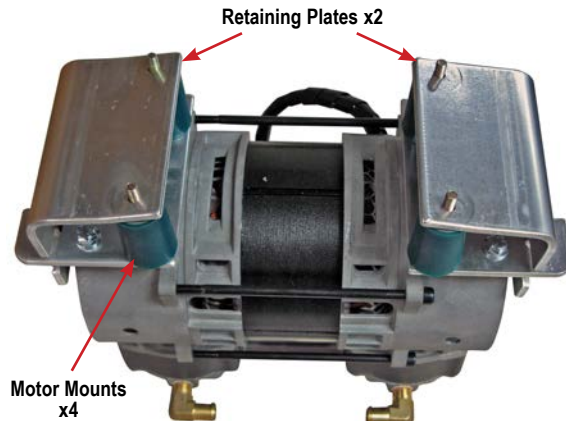

3. Turn compressor upright and attach intake hose to both intake fittings.

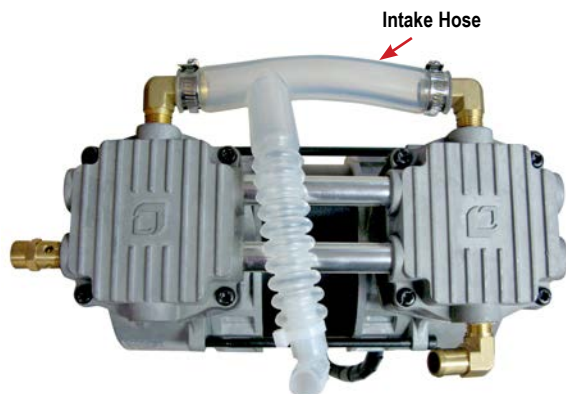

- Carefully place compressor in compressor box so that motor mount threads are protruding through the holes in the base of the unit.
- Lean unit backwards slightly and reinstall motor mount nuts.

**NOTE**– Ensure the compressor mounting and retaining plates are positioned properly to prevent excessive noise and vibration.

- Reconnect intake hose beneath intake filter.
- Rotate heat exchange tube to the left 90°.
- Install compressor filter by attaching tubing and ladder clamps to compressor exhaust fitting and heat exchange tube. Ensure heat exchange tube is not touching mounting plate or fan guard.
- Reconnect compressor electrical connector.

## COOLING FAN

The cooling fan provides a constant air flow to cool the compressor. The cooling fan is located in the bottom of the unit below the compressor.

A defective cooling fan may cause the compressor's internal thermo-protective (thermal cut off) device to activate and shut the compressor off. Should this condition occur, the compressor will require several minutes for the thermo-protective device to reset.

### If the cooling fan is defective, it must be replaced:

- Make sure the unit is unplugged from the wall outlet.
- Use the Cabinet Removal instructions listed previously to open the unit.
- Use the To Remove the Compressor instructions listed under Compressor.
- Disconnect the cooling fan connector from the PC board.
- Note the position of the fan, wires and fan guard before removing the four retaining screws that secure the fan to the base of the unit.
- Remove the defective fan and secure the replacement fan in position with the four retaining screws.

**NOTE**– When installing the fan, be sure the air flow directional arrow on the side of the fan is directed away from the compressor and fan guard is reinstalled properly.

- Reconnect the electrical connector.
- Reinstall the compressor.

## FLOW METER

The DeVilbiss 1025 series oxygen concentrator flow meter (1025D-607) has an operating flow rate of 2-10 LPM. Flows below 2 LPM may cause the low flow alarm to activate.

**NOTE**– Do not use a low output flow meter.



Locking Screw

The flow meter is pressure compensated and has an accuracy level of  $\pm 5\%$  of full scale at all liter flows except at 10 LPM. Accuracy at 10LPM is  $+0\% / -5\%$ . The flow meter can be locked using a 1/16th inch Allen wrench and tightening the locking screw behind the flow meter knob.

### To check for leaks in the flow meter tubing:

- Check for leaks using a certified leak detection solution such as Snoop® or equivalent (must not contain ethylene glycol).
- Apply leak test solution to all fittings and hose connections with the unit running.



### CAUTION

Do not apply leak test solution to any part of the rotary valve or the main PC Board assembly.

- If an air leak is present, the solution will bubble. All leaks should be repaired before putting the concentrator back in service.



### WARNING

Electric Shock Hazard. Use caution when leak testing near electrical connections.

### To replace the flow meter:

- Make sure the unit is unplugged from the wall outlet.
- Use the Cabinet Removal instructions listed previously to open the unit.
- From behind the front cabinet, remove the 2 hoses from the flow meter.
- Unscrew both the top and bottom flow meter fittings and remove the flow meter by pushing it out through the front cabinet.
- Install new flow meter and reconnect hoses.

## HOURLY METER

The digital hour meter can be seen on the status indicator panel and is mounted directly onto the PC board. If the hour meter malfunctions, the PC board will need to be replaced.

Refer to PC board replacement instructions on page 24.

## MANIFOLD

The manifold is attached to the accumulator tank and performs the same function as a purge harness. It directs a small amount of pressurized oxygen into the discharging sieve bed to aid the nitrogen exhaust process while it ensures that the majority of pressurized oxygen is directed into the accumulator tank. The manifold also prevents reverse flow of oxygen from the accumulator to the sieve beds.

See CHECK VALVES: MANIFOLD and SIEVE in this manual for additional information.

## MOLECULAR SIEVE BEDS

The build and release of pressure in the sieve beds indicates the health of the sieve material and the operation of contributing components. Determine 'good' or expected pressures for your altitude by testing bed pressures on multiple oxygen concentrators that are producing at least 93% purity.

Check sieve bed pressures at the accumulator tank using the manifold test point or the accumulator tank "T" fitting. See Figures below



Accumulator "T" Fitting

Manifold

**NOTE**– The pressure will rise and fall as it cycles through the rotary valve. The pressure swing will be approximately 4-5 psi.

Also consider the acceptable pressure range for various altitudes as shown below.

TYPICAL PEAK ACCUMULATOR TANK PRESSURE RANGE @ 10LPM		
Altitude	Psi	kPa
0 to 457 m 0 to 1500 ft.	25-36	172-248
457 to 914 m 1500 to 3000 ft.	21-33	145-228
914 to 1524 m 3000 to 5000 ft.	21-30	145-207

### To test sieve bed pressures:

- Remove the plugged piece of 1/16" tubing from the accumulator tank.
- Connect the pressure gauge to the test point and observe the cycling of pressures. Refer to the section on Normal Operating Sequence and also Accumulator Pressure Test.
  - If it is determined that the valve is not cycling the pressure, refer to the section on Rotary Valve testing.
  - If the unit is cycling properly, allow it to operate for 20 minutes.
- After 20 minutes of operation, observe the high and low pressures and check the oxygen concentration level.
  - If the pressures are within the expected range and the oxygen concentration is within specification, the sieve material is effective.
  - If pressures are not within the expected range and/or the oxygen concentration is not within specification, refer to the Simplified Troubleshooting Table in this manual to determine the proper corrective action.

**NOTE**– If the molecular sieve material is found to be no longer effective, first search for the source of a malfunction in the system; then, for a cause for contamination (such as leaks) and take corrective action.

### To replace the molecular sieve beds:

**NOTE**– Make sure that the sealing caps remain on the new sieve beds until just prior to connecting hoses and tubing.

- Ensure any contamination problem has been corrected.
- Ensure the unit is unplugged from the wall outlet.

- Cut the plastic cable ties that secure the sieve beds to the internal structure of the unit.
- Remove the tubing from the fittings at the top of each sieve bed.
- Remove the hose clamps and hose from the bottom of the sieve beds.
- Install new sieve beds in reverse order using new plastic cable ties. Position the new beds so that the bed serial number label is at the top of the unit.
- Leak test all connections with a certified leak detection solution such as Snoop® or equivalent (must not contain ethylene glycol). Apply leak test solution to all fittings and hose connections with unit running. If an air leak is present, the solution will bubble. All leaks should be repaired before putting the unit back in service.



### CAUTION

Do not apply leak test solution to any part of the rotary valve or the main PC Board assembly.

## POWER CORD

### To replace the power cord - 120 volt units only:

- Make sure the unit is unplugged from the wall outlet.
- Use the Cabinet Removal instructions listed previously to open the unit.
- Disconnect the power cord connector.
- Note wire colors and socket locations before removing wires.
- Using a pair of duckbill pliers, squeeze the power cord strain relief and pull it out of the base of the unit.
- Insert a new power cord through the hole in the base of the unit and secure with strain relief.
- Insert sockets into connector housing and then reconnect the power cord connector.
- Replace back cabinet and secure with the six screws.

## POWER SWITCH

### To replace the power switch:

- Make sure the unit is unplugged from the wall outlet.
- Use the Cabinet Removal instructions listed previously to open the unit.
- Note the position of the wires and switch before removing the wires from the switch terminals.
- While squeezing the locking tabs on the top and bottom of the switch, push the switch out of the front of the unit.
- Install the new switch in the correct orientation making sure that it locks into position.
- Reconnect the wires to the switch terminals.

#### Switch Detail

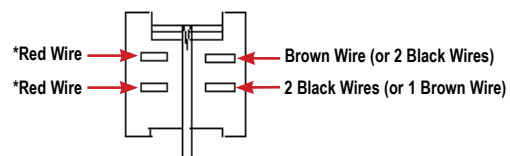

\*Either red wire can be connected to either left hand terminal of the switch



## PRESSURE REGULATOR

The 1025 series has two pressure regulators. One regulates the outlet pressure to the patient and the other regulates pressure to the auxiliary oxygen port. The regulator located at the top of the accumulator tank is connected to the OSD and stabilizes the flow of oxygen to the patient and establishes back pressure on the system. It is pre-set at  $20 \pm 1$  psi ( $137.8 \pm 7$  kPa) and should not have to be adjusted in the field.

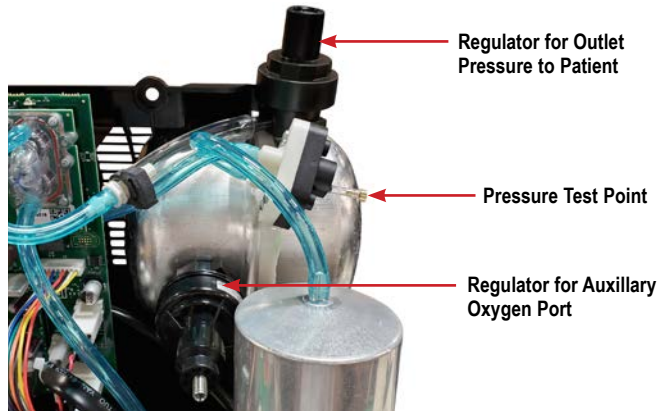

It is not necessary to test the pressure regulator unless there is a problem with flow rate accuracy. The following test is only needed when troubleshooting flow rate issues.

### To test the pressure regulator:

1. Turn the unit "On."
2. Set the flow meter at 2-3 lpm.
3. Attach a pressure gauge (part #PVO2D-601) to the oxygen outlet to obtain a reference pressure. Use this reference pressure to determine if further testing is needed.
4. If the reference pressure varies from the expected pressure by more than  $\pm 1$  psi or  $\pm 7$  kPa, connect a 'T' fitting directly between the pressure regulator fitting and the pressure regulator tubing and attach the pressure gauge to the 3rd leg of the 'T' fitting. If the pressure reading is not within  $20 \pm 1$  psi ( $137.8 \pm 7$  kPa), adjustment to the pressure regulator is required.

### To adjust the pressure regulator:

1. If necessary, the pressure regulator can be adjusted by turning the allen screw on top of the regulator until the pressure is within specification. Turn clockwise to increase the pressure, and counterclockwise to decrease the pressure.

**NOTE**– Before adjusting the pressure regulator, make sure no leaks exist by using a certified leak detection solution such as Snoop® or equivalent (must not contain ethylene glycol).



### CAUTION

Do not apply leak test solution to any part of the rotary valve or the main PC Board assembly.

A malfunction in the pressure regulator will cause either a loss or fluctuation in the oxygen flow which will be seen on the flow meter or a decrease in oxygen concentration.

### To replace the pressure regulator:

1. Make sure the unit is unplugged from the wall outlet.
2. Use the Cabinet Removal instructions listed previously to open the unit.
3. Remove the tubing clamp and tubing from the pressure regulator.
4. Unscrew the regulator from the accumulator tank.
5. Install a new regulator on the accumulator tank and attach the tubing and tubing clamp.

## PRINTED CIRCUIT BOARD

The printed circuit (PC) board is responsible for monitoring and controlling the Drive DeVilbiss Oxygen Concentrator.

The PC board has preset alerts for low flow and power failure. Should any of the alert values be exceeded, the patient alert system will activate.

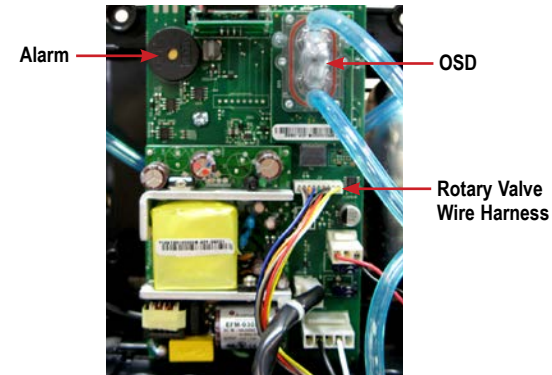

**NOTE**– If the concentrator has been unused for an extended period, the unit must run 20 minutes before the power fail alert will be enabled. This alert is powered by a capacitor on the PC board.



### CAUTION

Do not apply any force or flex to the PC Board when connecting or disconnecting electronic or pneumatic components. Damage to the electronic assembly is possible.

### To remove and replace the PC board:

1. Make sure the unit is unplugged from the wall outlet.
2. Use the Cabinet Removal instructions listed previously to open the unit.
3. Disconnect all wires and electrical connectors.
4. Remove the 1/8" (3.2mm) tubing from both fittings on the oxygen sensor.
5. Remove the screw that secures the board to the unit and remove the PC board.
6. Install the new PC board and secure it using the screw.
7. Reconnect all electrical wires, connectors and the tubing to the sensor.

## ROTARY VALVE

The timed rotary valve alternately distributes pressure supplied by the compressor to the sieve beds. While one bed is being pressurized the other bed is being exhausted through the valve exhaust port.

The valve contains two revolving discs powered by a stepper motor to cycle the pressure between the beds. DC voltage is supplied by the PC board to the motor windings causing the internal discs to turn and direct pressure to the proper sieve bed.

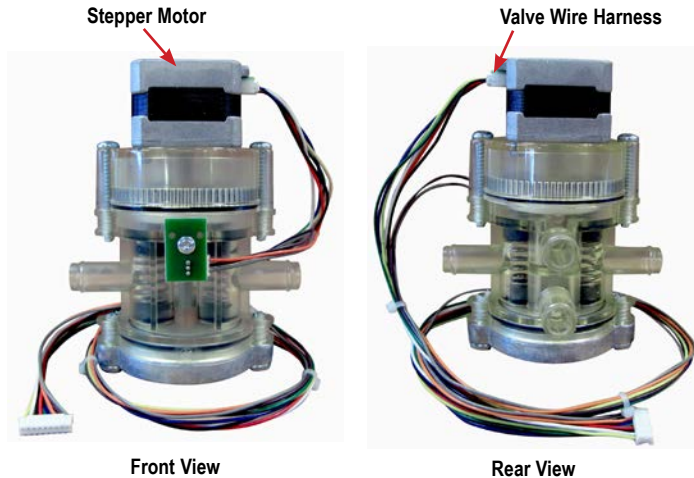

If the rotary valve is not shifting properly, one bed may pressurize continuously; the pressure building until the pressure relief valve on the compressor releases the excess with a sputtering sound.

There are several reasons why the rotary valve could malfunction; therefore the cause of failure must be determined before corrective action can be taken.

### To test the rotary valve:

1. Use the Cabinet Removal instructions listed previously to open the unit for testing.
2. Connect a pressure gauge to the test point on the accumulator tank to observe unit cycling and the high and low bed pressures. Refer to the section on Normal Operating Sequence and also Accumulator Pressure Test.
  - a. If it is determined that the valve is shifting properly and the high and low pressures are consistent, the valve is operating correctly.
  - b. If it is determined that the valve did not shift properly or the high pressures or low pressures are uneven, check the valve wire harness for any loose or broken connections. If harness connections are good, then the problem is caused by either the rotary valve or PC board.

### To replace the rotary valve:

1. Make sure the unit is unplugged from the wall outlet.
2. Use the Cabinet Removal instructions listed previously to open the unit.
3. Unplug valve wire harness from the valve.
4. Loosen clamps and remove bed hoses from each side of valve.
5. Loosen ladder clamps and remove pressure intake and exhaust hoses from backside of valve, then remove valve.
6. Install the new rotary valve by reversing the above procedure.

# FIGURES, DIAGRAMS AND PARTS LIST

## 1025 Unit with Auxiliary Oxygen Port

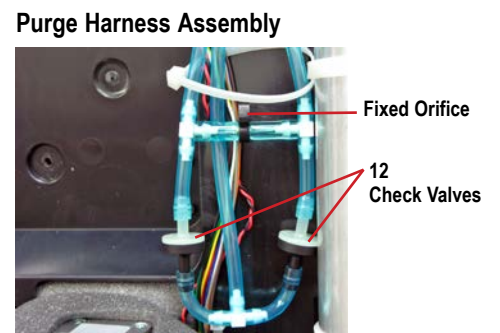
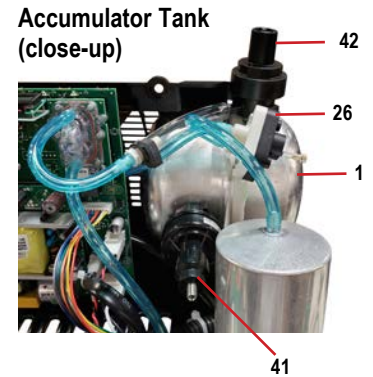
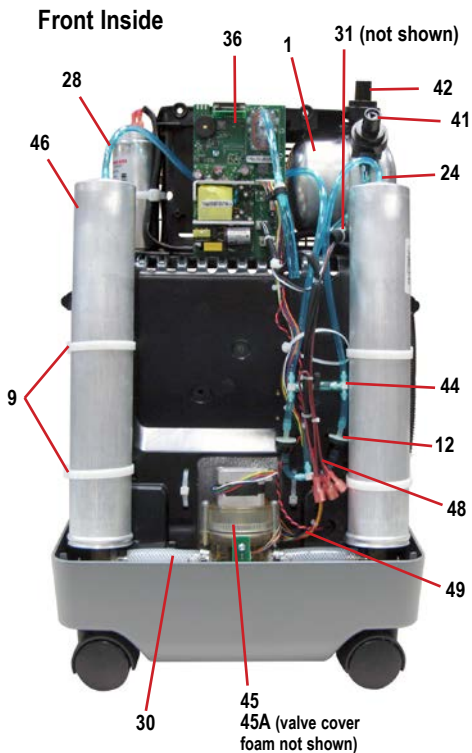
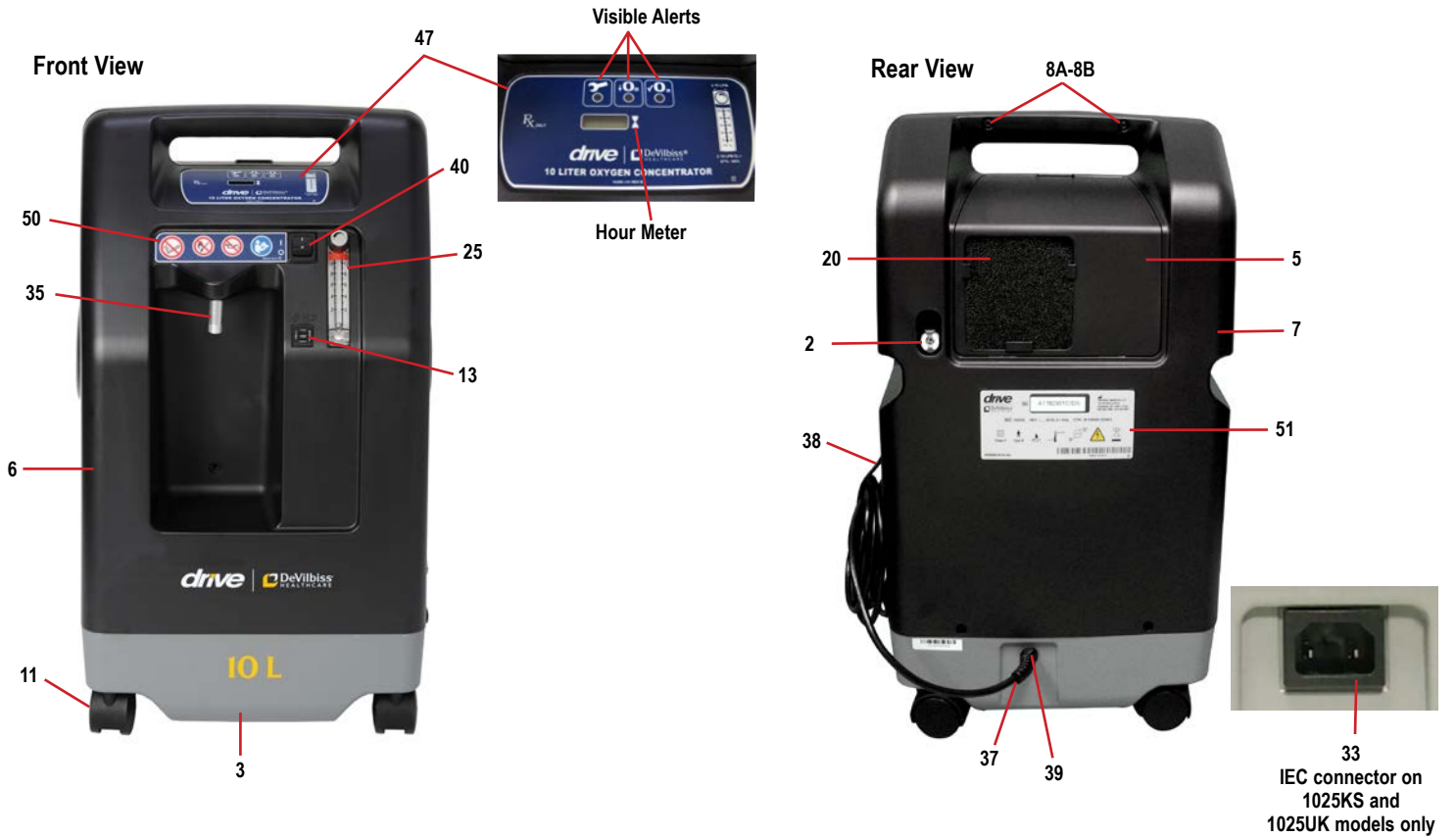



# FIGURES, DIAGRAMS AND PARTS LIST

## 1025 Unit with Auxiliary Oxygen Port

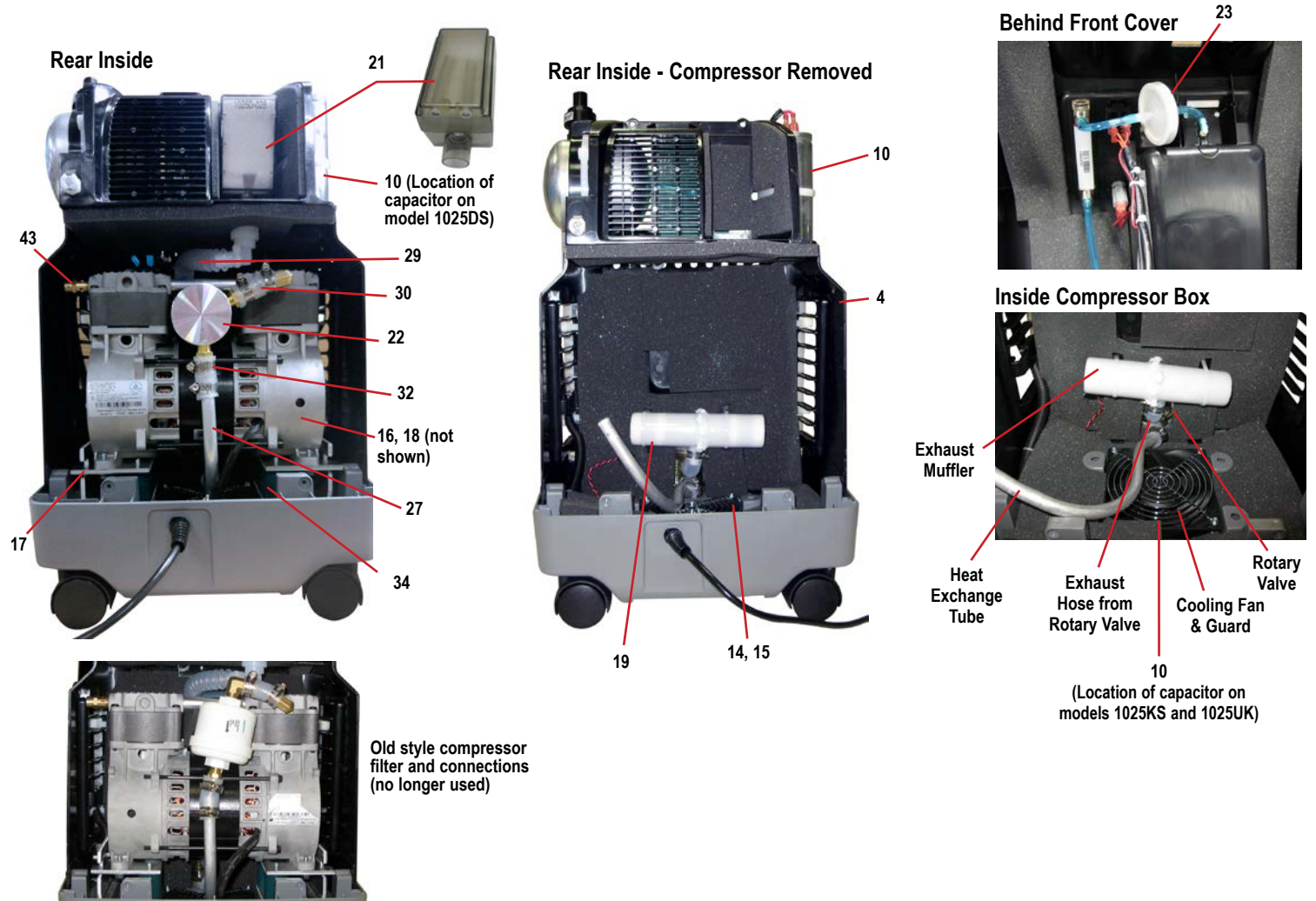

	PART DESCRIPTION	1025DS	1025KS	1025UK
1	Accumulator Tank	1025D-610	1025D-610	1025D-610
2	Auxiliary Oxygen Port	525DD-635	525DD-635	525DD-635
<b>Cabinet Parts:</b>				
3	Base	1025D-603	1025K-603	1025K-603
4	Compressor Box w/ Foam	1025D-615	1025D-615	1025D-615
5	Filter Door	525DD-639	525DD-639	525DD-639
6	Front Cover	525DD-611	525DD-611	525DD-611
7	Rear Cover	525DD-612	525DD-612	525DD-612
8A	Cabinet Screw (Machine)	525DD-628	525DD-628	525DD-628
8B	Cabinet Screw (Thread-forming)	525DD-636	525DD-636	525DD-636
9	Cable Tie (Large)	505DZ-617	505DZ-617	505DZ-617
10	Capacitor (Motor Start/Run)	1025DS-616	1025KS-616	1025UK-616
11	Caster, Non-locking	501DZ-603	501DZ-603	501DZ-603
12	Bed Check Valve	PVO2D-607	PVO2D-607	PVO2D-607
13	Circuit Breaker	1025D-613	1025K-613	1025K-613
14	Cooling Fan	1025D-634	1025D-634	1025D-634
15	Cooling Fan Guard	N/A	N/A	N/A
16	Compressor	1025D-625	1025K-625	1025K-625
17	Compressor Mounting Plate Package	1025D-632	1025D-632	1025D-632
18	Compressor Rebuild Kit	1025D-643	1025K-643	1025K-643
19	Exhaust Muffler	1025D-705	1025D-705	1025D-705

# FIGURES, DIAGRAMS AND PARTS LIST

	PART DESCRIPTION	1025DS	1025KS	1025UK
	<b>Filters:</b>			
20	Cabinet Air Filter	303DZ-605	303DZ-605	303DZ-605
21	Intake Bacteria Filter	1025D-605	1025D-605	1025D-605
22	Compressor Filter	1025D-682	1025D-682	1025D-682
23	Final Bacteria Filter	PV5LD-651	PV5LD-651	PV5LD-651
	<b>Fittings:</b>			
24	Accumulator Tank "Tee" (not shown)	444-582	444-582	444-582
25	Flow Meter	1025D-607	1025D-607	1025D-607
26	Purge Manifold	1025D-618	1025D-618	1025D-618
27	Heat Exchanger Tube	1025D-655	1025D-655	1025D-655
	<b>Hoses:</b>			
28	1/8" ID (Blue) (4' Lg)	444-554	444-554	444-554
29	Compressor Intake Hose (Silicone)	1025D-657	1025D-657	1025D-657
30	1/2" ID Silicone Braided (2' LG)	505DZ-634	505DZ-634	505DZ-634
	<b>Hose Clamps:</b>			
31	Plastic (1/4" ID Hose) (not shown)	N/A	N/A	N/A
32	Ladder Clamp (1/2" ID Hoses)	444-566	444-566	444-566
33	IEC Connector	N/A	N/A	N/A
34	Motor Mounts	1025D-609	1025D-609	1025D-609
35	Oxygen Outlet Port	525DD-606	525DD-606	525DD-606
36	PC Board	1025D-622	1025D-622	1025D-622
37	Power Cord w/ Strain Relief	PV5LD-618	VARIOUS	VARIOUS
38	Power Cord Strap	MC29D-657	MC29D-657	MC29D-657
39	Power Cord Strain Relief	505DZ-645	N/A	N/A
40	Power Switch	1025D-508	1025D-508	1025D-508
41	Pressure Regulator (8.5 PSI)	MC29D-612	MC29D-612	MC29D-612
42	Pressure Regulator (20 PSI)	1025D-612	1025D-612	1025D-612
43	Pressure Relief Valve	1025D-614	1025D-614	1025D-614
44	Purge Harness Assembly	1025D-617	1025D-617	1025D-617
45	Rotary Valve	515ADZ-702	515ADZ-702	515ADZ-702
45A	Valve Cover Foam	525DD-642	525DD-642	525DD-642
46	Sieve Bed	1025D-619	1025D-619	1025D-619
47	Top Cover Label	1025D-631	1025D-631	1025D-631
	<b>Wire Harness:</b>			
48	Main Harness	1025D-623	1025K-623	1025K-623
49	Rotary Valve Harness	525D-621	525D-621	525D-621
50	Front Label	1025D-627	1025D-627	1025D-627
51	Rating Label	1025DS-633	1025KS-633	1025UK-633

ACCESSORIES	
Carton with Shipping Inserts	1025D-606
Oxygen Outlet Connector - Plastic	XM-1
Casters, Locking	525DS-603
Transfill Caddy	525DD-650
Transfill Hose	PF1100TUB
High Flow (6-15 LPM) Bubble Humidifier	Salter Labs 7900 or equivalent
Low Flow (up to 6 LPM) Bubble Humidifier	Salter Labs 7600 or equivalent
High Flow Nasal Cannula	Salter Labs 1600HF or equivalent

TOOLS	
Service Kit	444-501
Pressure Gauge	PVO2D-601
Pressure Test Assembly	303DZ-637
Oxygen Analyzer (Max O <sub>2</sub> )	R217P62

## Pneumatic Diagram

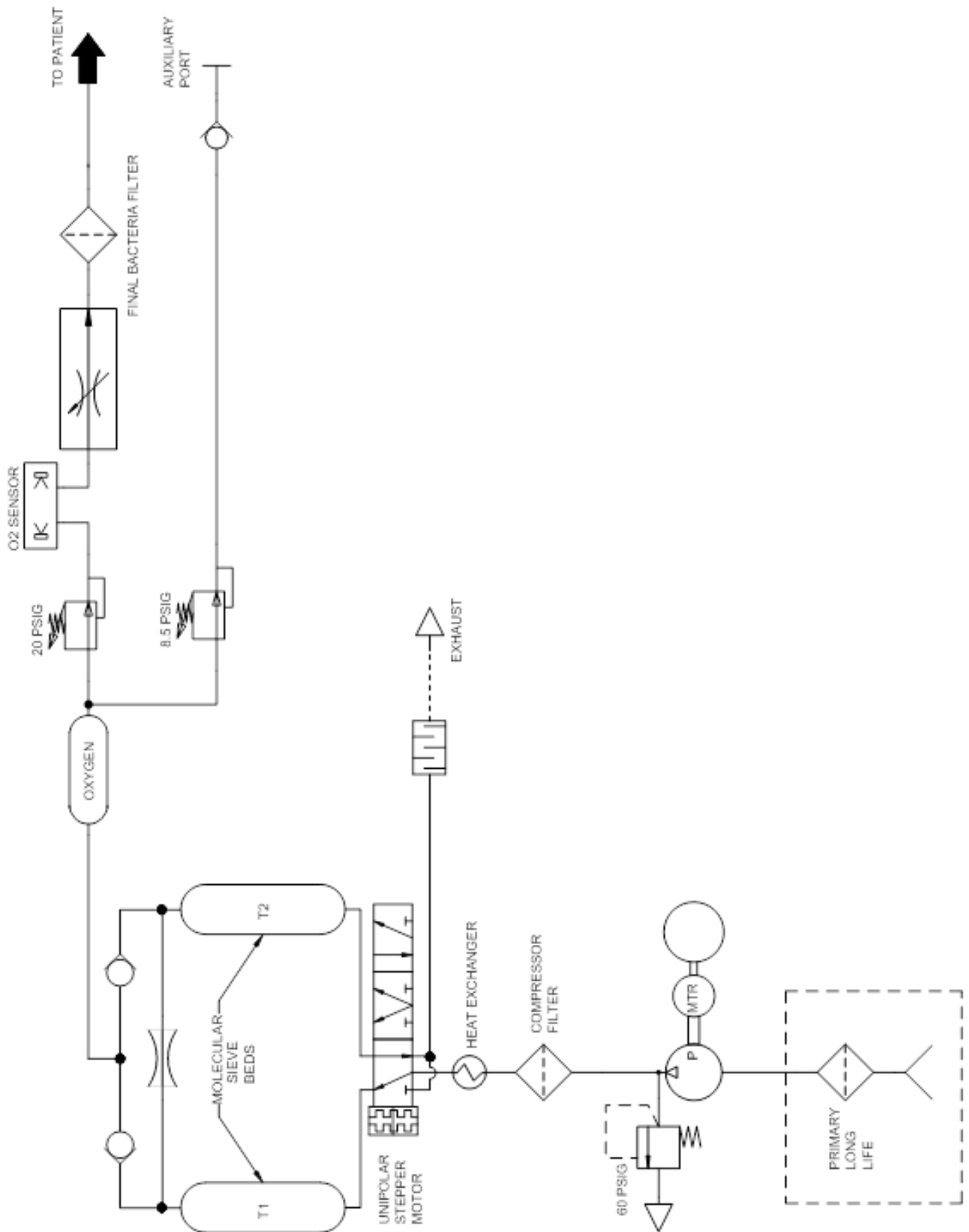

## Wiring Diagram

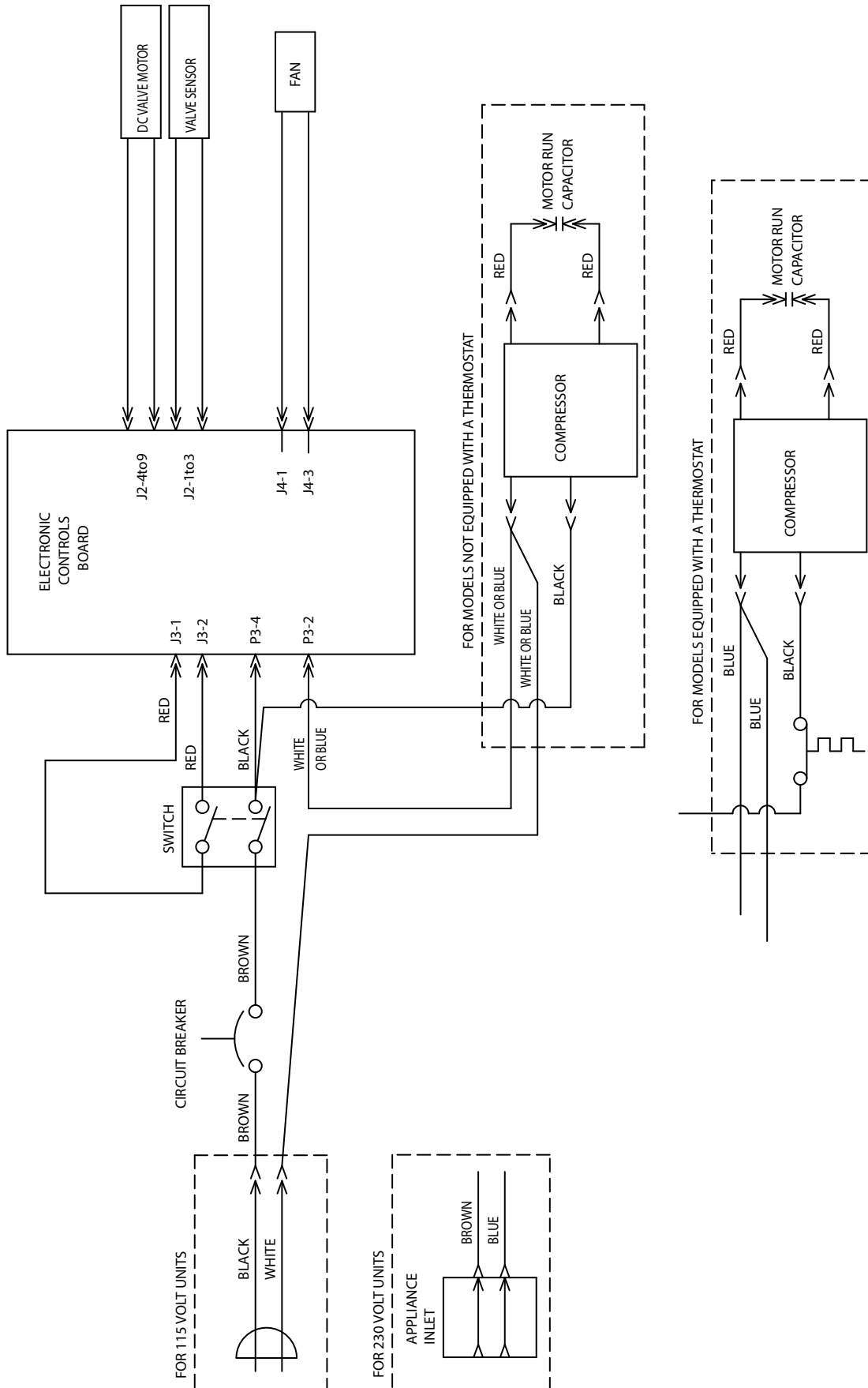

## ORDERING INFORMATION

When ordering components, instruction guides, or service manuals the following must be provided:

- Unit Catalog Number
- Unit Serial Number
- Part Number
- Quantity Required

DeVilbiss Concentrator 10 Liter Series Instruction Guide:

- A-1025                      1025DS, 1025KS & 1025UK      English, Spanish, French
- SE-1025-1                1025DS, 1025KS & 1025UK      English, Spanish, French, German, Italian, Dutch, Turkish, Portuguese, Polish
- SE-1025-2                1025DS, 1025KS & 1025UK      English, Greek, Danish, Swedish, Finnish, Norwegian, Czech, Slovak, Chinese (simplified)

DeVilbiss Concentrator 10 Liter Series Service Manual:

- LT-2329                    1025DS, 1025KS & 1025UK      English

DeVilbiss Oxygen Concentrator Service Log:

- A-1007                    All                                      English
- A-1007-PT                All                                      Portuguese
- A-1007-DE                All                                      German

Orders may be placed by calling:

- Customer Service        800-338-1988
- International Department 814-443-4881
- Europe                    +49 (0) 621-178-98-0

## RETURNS

Before returning units to the factory, call the Drive DeVilbiss Healthcare Customer Service Department (800-338-1988) or (814-443-4881) to obtain a return authorization number. Include in the package a note indicating the return authorization number along with your company name, address, phone number, and account number. The return authorization number should also be written on the outside of the package.

To expedite your order for non-warranty parts, the following information should be given to the representative:

- Catalog number
- Serial number
- Hour meter reading for each concentrator
- Account number
- Company name and address
- Description of problem

## WARRANTY

Drive DeVilbiss Healthcare warrants the Drive DeVilbiss 10 Liter Oxygen Concentrator under the conditions and limitations stated below. Drive DeVilbiss warrants this equipment to be free from defects in workmanship and materials for three (3) years from date of factory shipment to the original purchaser, (typically the healthcare provider) unless contractually specified otherwise. This warranty is limited to the Buyer of new equipment purchased directly from Drive DeVilbiss, or one of its Providers, Distributors, or Agents. Drive DeVilbiss' obligation under this warranty is limited to product repair (parts and labor) at its factory or at an Authorized Service Center. Routine maintenance items, such as filters, are not covered under this warranty, nor does it cover normal wear and tear.

### Warranty Claims Submissions

The original purchaser must submit any warranty claim to Drive DeVilbiss or to an Authorized Service Center. Upon verification of the warranty status, instructions will be issued. For all returns, the original purchaser must (1) properly package the unit in a DeVilbiss approved shipping container, (2) properly identify the claim with the Return Authorization Number, and (3) send the shipment freight prepaid. Service under this warranty must be performed by Drive DeVilbiss and/or an Authorized Service Center.

**i NOTE**– *This warranty does not obligate Drive DeVilbiss to provide a loaner unit during the time that an oxygen concentrator is undergoing repair.*

**i NOTE**– *Replacement components are warranted for the unexpired portion of the original Limited Warranty.*

This warranty shall be voided, and Drive DeVilbiss shall be relieved of any obligation or liability if:

- The device has been misused, abused, tampered with, or used improperly during this period.
- Malfunction results from inadequate cleaning or failure to follow the instructions.
- The equipment is operated or maintained outside the parameters indicated in the Drive DeVilbiss operating and service instructions.
- Unqualified service personnel conduct routine maintenance or servicing.
- Unauthorized parts or components (i.e., regenerated sieve material) are used to repair or alter the equipment.
- Unapproved filters are used with the unit.

THERE IS NO OTHER EXPRESS WARRANTY. IMPLIED WARRANTIES, INCLUDING THOSE OF MERCHANTABILITY AND FITNESS FOR A PARTICULAR PURPOSE, ARE LIMITED TO THE DURATION OF THE EXPRESS LIMITED WARRANTY AND TO THE EXTENT PERMITTED BY LAW ANY AND ALL IMPLIED WARRANTIES ARE EXCLUDED. THIS IS THE EXCLUSIVE REMEDY AND LIABILITY FOR CONSEQUENTIAL AND INCIDENTAL DAMAGES UNDER ANY AND ALL WARRANTIES ARE EXCLUDED TO THE EXTENT EXCLUSION IS PERMITTED BY LAW. SOME STATES DO NOT ALLOW LIMITATIONS ON HOW LONG AN IMPLIED WARRANTY LASTS, OR THE LIMITATION OR EXCLUSION OF CONSEQUENTIAL OR INCIDENTAL DAMAGES, SO THE ABOVE LIMITATION OR EXCLUSION MAY NOT APPLY TO YOU.

This warranty gives you specific legal rights, and you may also have other rights that vary from state to state.

**i NOTE**– *International warranties may vary.*

### Ordering and Returning Parts

#### Drive DeVilbiss Customer Service Contact Information

Customer Service (USA): 877-224-0946

International Department: [DHCinternational@DeVilbissHC.com](mailto:DHCinternational@DeVilbissHC.com)

#### Ordering Non-Warranty Replacement Parts

Order non-warranty parts and literature from your Drive DeVilbiss provider. To expedite the process, be prepared to provide the following information:

- Account and ship-to numbers
- Ship-to address
- Part numbers and/or descriptions
- Quantity required
- Unit catalog number
- Unit serial number
- Hours of operation

### Return and Disposal

This device may not be disposed of with household waste. After use of the device, please return the device to the provider for disposal. This device contains electrical and/or electronic components that must be recycled per EU Directive 2012/19/EU-Waste Electrical and Electronic Equipment (WEEE). Non-infectious used accessories (e.g. nasal cannula) can be disposed of as residential waste. The disposal of infectious accessories (e.g. nasal cannula from an infected user) must be made via an approved waste disposal company. Names and addresses can be obtained from the local municipality.



# SPECIFICATIONS

<b>DEVILBISS 10-LITER SERIES</b>			
Catalog Number	1025DS	1025KS	1025UK
Delivery Rate	2 to 10 LPM	2 to 10 LPM	2 to 10 LPM
Maximum Recommended Flow (@ nominal outlet pressures of zero and 7 kPa)**	10 LPM	10 LPM	10 LPM
Outlet Pressure	20.0 ± 1.0 psi (138 kPa +/- 7 kPa)	20.0 ± 1.0 psi (138 kPa +/- 7 kPa)	20.0 ± 1.0 psi (138 kPa +/- 7 kPa)
Auxiliary Oxygen Port **	Outlet Pressure: <15 psi Outlet Flow: 2 LPM	Outlet Pressure: <15 psi Outlet Flow: 2 LPM	Outlet Pressure: <15 psi Outlet Flow: 2 LPM
Electrical Rating	120 V, 60 Hz, 6.1 Amp	230 V~, 50 Hz, 3.2 Amp	240 V~, 50 Hz, 3.2 Amp
Operating Voltage Range	102-132 V~, 60 Hz	195-253 V~, 50 Hz	204-264 V~, 50 Hz
Oxygen Percentage	2-10 LPM=87%-96%	2-10 LPM=93% +3%/-6%	2-10 LPM=93% +3%/-6%
Operating Altitude	Across the voltage range: No degradation of performance		Across the voltage range: No degradation of performance
(tested at 70°F {21°C} only) 0-1500 M (0-5000 ft)	Across the voltage range: No degradation of performance		Across the voltage range: No degradation of performance
Operating Environment Range*	No degradation in performance across the operating voltage range.		
41°F (5°C) to 95°F (35°C), humidity range of 15% to 93% non-condensing	No degradation in performance across the operating voltage range.		
Power Consumption	120 vac, 60HZ: 639 watts average	230 vac, 50Hz: 664 watts average	240 vac, 50Hz: 670 watts average
Weight	42 lbs. (19 Kilograms)	42 lbs. (19 Kilograms)	42 lbs. (19 Kilograms)
Safe Working Load	53 lbs. (24 Kilograms)	53 lbs. (24 Kilograms)	53 lbs. (24 Kilograms)
Sound Pressure Level at 3 and 10LPM	<59 dBA	<57 dBA	<57 dBA
Sound Power Level at 3 and 10 LPM	<69 dBA	<67 dBA	<67 dBA
Dimensions	24.5"H x 13.5"W x 12"D (62.2 x 34.2 x 30.4 cm)	24.5"H x 13.5"W x 12"D (62.2 x 34.2 x 30.4 cm)	24.5"H x 13.5"W x 12"D (62.2 x 34.2 x 30.4 cm)
Maximum Limited Pressure	35 PSIG (241 kPa)	35 PSIG (241 kPa)	35 PSIG (241 kPa)
Operating System	Time Cycle / Pressure Swing		
Low Oxygen Indicator	<82% low oxygen <60% very low oxygen		
Storage Conditions	-13°F (-25°C) to 158°F (70°C), humidity range of 15% to 93% non-condensing		
Equipment Class and Type	<input type="checkbox"/> Class II Equipment Double Insulated; ⚠ Type B Applied Part Ordinary Equipment, IP21	<input type="checkbox"/> Class II Equipment Double Insulated; ⚠ Type B Applied Part IP21	<input type="checkbox"/> Class II Equipment Double Insulated; ⚠ Type B Applied Part IP21
Approval Body and Safety Standard	TUV ANSI/AAMI ES60601-1:2005+A2 (R2012) +A1 IEC 60601-1-6:2010 IEC 60601-1-11:2015 ISO 80601-2-69:2014 CAN/CSA-C22.2 No. 60601-1-14 CAN/CSA-C22.2 No. 60601-1-6:11 CAN/CSA-C22.2 No. 60601-1-11:15 CAN/CSA-C22.2 No. 80601-2-69:16	TUV IEC 60601-1:2012 IEC 60601-1-6:2010+A1 IEC 60601-1-11:2015 EN ISO 80601-2-69:2014	TUV IEC 60601-1:2012 IEC 60601-1-6:2010+A1 IEC 60601-1-11:2015 EN ISO 80601-2-69:2014
CE mark	No	Yes	Yes
EMC Compliance To	EN60601-1-2	EN60601-1-2	EN60601-1-2

\***NOTE**– The OSD performance at 41°F (5°C) to 95°F (35°C), 93% R.H. through voltage range on the 1025 verified at 670m.

\*\*The maximum recommended flow is 6 LPM when an oxygen bottle is being filled with oxygen from the auxiliary oxygen port.

Specifications subject to change without notice.

## Oxygen Concentration vs Flow Rate

Flow L/m	%O <sub>2</sub>
10	87% - 92%
9	87% - 93%
8	87% - 95%
7	87% - 96%
6	87% - 96%
5	87% - 96%
4	87% - 95%
3	87% - 95%
2	87% - 94%

# ELECTROMAGNETIC COMPATIBILITY INFORMATION

## ELECTROMAGNETIC COMPATIBILITY INFORMATION



### WARNING

#### MR Unsafe

Do not bring the device or accessories into a Magnetic Resonance (MR) environment as it may cause unacceptable risk to the patient or damage to the oxygen concentrator or MR medical devices. The device and accessories have not been evaluated for safety in an MR environment.

Do not use the device or accessories in an environment with electromagnetic equipment such as CT scanners, Diathermy, RFID and electromagnetic security systems (metal detectors) as it may cause unacceptable risk to the patient or damage to the oxygen concentrator. Some electromagnetic sources may not be apparent, if you notice any unexplained changes in the performance of this device, if it is making unusual or harsh sounds, disconnect the power cord and discontinue use. Contact your home care provider.

This device is suitable for use in home and healthcare environments except for near active HF SURGICAL EQUIPMENT and the RF shielded room of an ME SYSTEM for magnetic resonance imaging, where the intensity of Electromagnetic DISTURBANCES is high.



### WARNING

Use of this equipment adjacent to or stacked with other equipment should be avoided because it could result in improper operation. If such use is necessary, this equipment and the other equipment should be observed to verify that they are operating normally.



### WARNING

Portable RF communications equipment (including peripherals such as antenna cables and external antennas) should be used no closer than 30 cm (12 inches) to any part of the oxygen concentrator, including cables specified by the manufacturer. Otherwise, degradation of the performance of this equipment could result.

## Electromagnetic Compatibility

TEST DESCRIPTION	SPECIFICATION	NOTES	RESULTS
<b>CISPR11 &amp; IEC 60601-1-2:2014 (4TH EDITION)</b>			
RF Emissions	CISPR 11	Group 1	Complies
RF Emissions	CISPR 11	Class B	Complies
Harmonic Current Emissions	EN 61000-3-2:2014	AC Input	Complies
Voltage Fluctuations & Flicker	EN 61000-3-3:2013	AC Input	Complies
Electrostatic Discharge Immunity	EN 61000-4-2:2008	±15kV (Air) 8kV (Contact)	Complies
Radiated Electromagnetic Field Immunity	EN 61000-4-3:2006	80MHz to 2.7GHz @ 10V/m; 80% AM at 1kHz	Complies
Fast Transient/Burst Immunity	EN 61000-4-4:2004	±2kV for Power Lines & ±1kV for I/O Lines	Complies
Surge Immunity	EN 61000-4-5:2006	±1kV differential ±2kV common	Complies
Conducted RF Immunity	EN 61000-4-6:2009	3Vrms 150kHz to 80MHz 6Vrms ISM Band frequencies between 150kHz-80MHz	Complies
Magnetic Field Immunity	EN 61000-4-8:2010	30A/m	Complies
Voltage Dips, Short Interruptions & Variations	EN 61000-4-11:2004	100% dip 0.5 cycle 100% dip 1 cycles 30% dip 25 cycles 100% dip 5 sec	Complies





**DeVilbiss Healthcare LLC**

100 DeVilbiss Drive  
Somerset, PA 15501-2125  
USA  
800-338-1988 • 814-443-4881

**Drive DeVilbiss Healthcare Ltd.**

Heathfield Lane  
Birkenshaw  
West Yorkshire BD11 2HW  
ENGLAND  
+44 (0) 845 0600 333

**Drive DeVilbiss Australia Pty Limited**

Building F, 2 Hudson Ave  
Castle Hill, NSW 2154  
AUSTRALIA  
+61 02 9899 3144

**Drive DeVilbiss Healthcare France**

Chaussée du Ban la Dame  
Parc d'activités Eiffel Energie  
ZAC du Ban la Dame - BP 19  
54390 Frouard  
FRANCE  
+33 (0) 3 83 495 495



**DeVilbiss Healthcare GmbH**

Kamenzer Straße 3  
68309 Mannheim  
GERMANY  
+49 (0) 621-178-98-0

DeVilbiss Healthcare LLC • 100 DeVilbiss Drive • Somerset, PA 15501 • USA

800-338-1988 • 814-443-4881 • [www.DeVilbissHealthcare.com](http://www.DeVilbissHealthcare.com)

DeVilbiss® and OSD® are registered trademarks of DeVilbiss Healthcare. Teflon® is a registered trademark of DuPont. Snoop® is a registered trademark of SWAGELOK

© 2020 DeVilbiss Healthcare LLC. 08.20 All Rights Reserved.

LT-2329 Rev D